



	922E	925E
<b>Engine</b>	Cummins QSB 6.7	Cummins QSB 6.7
<b>Net Power</b>	119 kW (160 hp/162 ps) @ 2,100 rpm	129 kW (173 hp/175 ps) @ 2,000 rpm
<b>Operating Weight</b>	22,800 kg (50,265 lb)	25,500 kg (58,202 lb)
<b>Bucket Capacity</b>	0.9-1.2 m <sup>3</sup> (1.18 - 1.57 yd <sup>3</sup> )	0.58-1.4 m <sup>3</sup> (0.65 - 1.83 yd <sup>3</sup> )

# 922E/925E EXCAVATOR

TOUGH WORLD. TOUGH EQUIPMENT.





# TOUGH WORLD. TOUGH EQUIPMENT.

You don't need to be told it's a tough world. It's your reality, you live it every day and you know how hard it can be on your people and your machines. It's getting tougher to make your business pay too, with rising costs, increasing legislation and greater competition. We understand and we've put that understanding into action with our new 922E/925E.

## 922E/925E. NO TOUGH COMPROMISES, JUST EVERYTHING YOU NEED AND NOTHING YOU DON'T

The construction equipment industry has seen an expensive trend towards over-engineered products. Some manufacturers genuinely believe that adding cost, adds perceived value in customers' eyes.

## BUT YOU TOLD US A DIFFERENT STORY

You asked for a tough, well-engineered excavator, which can do the job. Any job.

### YOU WANTED A LARGE-SIZED EXCAVATOR THAT DELIVERS ON 3 ESSENTIAL NEEDS;

1



**FIT FOR PURPOSE**

2



**UPTIME AND SUPPORT**

3



**TOTAL COST OF OWNERSHIP**



With the 922E/925E, we've met your challenge and given you everything you want – without compromise.



### TOUGH FACTS

#### AWARD WINNING DESIGN

Our UK-based design team has invested thousands of man hours to really understand how our machines are used every day. This insight shapes our innovative approach to product design. Our design team recently won a prestigious Red Dot Award for our D-Series Grader and our New F-Series shares this award-winning design DNA.

#### TOUGH RESEARCH AND TESTING

Finding tougher, smarter, safer and more cost-effective ways of working matters to you. It matters to us too. Our new Global Research & Development Centre is a great example of this customer focused approach. We've established an international team of industry experts, backed up with the latest world-class technology, all focused on delivering greater value to you.

#### TOUGH QUALITY STANDARDS

When it comes to quality, we let our actions to speak for themselves.

We follow a rigorous Six Sigma methodology and consistently achieve ISO 9001 standards.



# FIT FOR PURPOSE

Firstly, you need to know that your machine is up to the job; breaking, digging, lifting, working hard – anytime – anywhere. Excavators have got to be tough and they've got to perform.

## OUR NEW 922E/925E HIGH PERFORMANCE FROM THE GROUND UP

- 1 TOUGHER UNDERCARRIAGE**  
With X-shaped frame built from high strength tensile steel, the 922E/925E's undercarriage is designed to withstand the toughest conditions. Continuous digging, lifting and loading can put excessive stress on machines. The 922E/925E has a long track beam and crawler system that guarantees greater stability. The structure also helps protect key components such as the travel motor from undue stress.
- 2 TOUGHER COMPONENTS**  
The undercarriage components are tougher too. Heavy duty rollers, reinforced idler frame and optional full track guard guarantee the integrity of our undercarriage. It's this core strength that enables our customers to keep working and earning – around the clock.
- 3 TOUGHER UPPER STRUCTURE**  
The upper structure of the 922E/925E is built around a reinforced and well-engineered H-beam, allowing the boom to be mounted exactly in the center of the machine. This central positioning helps the boom cope with more stress on the attachment group. It also means better distribution of weight and tension along the entire machine.
- 4 SAFER CAB**  
Our cabs are designed to protect your most important asset. Your operator. ROPS (Roll Over Protection System) and FOPS (Falling Object Protection System) safeguard your most important asset: your operator in the toughest environment. Visibility is key to protecting your operator and workers on site. The large glass surface area, increased by 15% on the E-series cab compared with our previous model, combined with the rear-view camera, provides an extraordinary view of the 922E/925E's surroundings.
- 5 TOUGHER BOOM AND ARM**  
The 922E/925E features a tougher, reinforced heavy duty boom and arm built from high-strength tensile steel, with castings and forgings in high stress areas for heavy-duty performance and maximum uptime. We also use over-sized pins to allow the 922E/925E, not just to work harder, but to work harder for longer. Our confidence in our machines is underlined by one of the most comprehensive warranties in the industry.



**6 SIMPLY MULTIFUNCTIONAL**  
Switching attachments like buckets, breakers and shears can be time consuming and hazardous. We've made it fast, safe and simple with LiuGong's quick coupler and powerlatch tilt coupler. These are perfectly matched to a range of genuine LiuGong attachments including; buckets and breakers which can be changed from the seat of the cab in less than a minute, quick, safe and easy.

**7 SIMPLER TO DO THE JOB RIGHT**  
Six selectable work modes equip even the newest operator with the skills of an expert, allowing them to perfectly match machine performance with the job, whatever that job may be.



**8 FASTER CYCLE TIMES**  
Greater hydraulic flow and higher swing speeds combine to improve cycle times by 12% on tasks such as truck loading, digging, trenching and backfilling compared with our previous model.

**JOBSITE FACT: ANYTIME**  
 10,000 hours registered and still working hard.  
 Tapegyseg Co. Hungary  
 "We use our LiuGong excavator for breaking down large stone and concrete sections. In two years we have not had a problem and our machines are working 10-11 hours a day, six days a week."

**JOBSITE FACT: ANYWHERE!**  
 -49°C  
 Temperatures drop but the work rate stays high.  
 LiuGong Excavators played a key part in supporting China's Polar Exploration team. Extreme temperatures, high altitudes, strong winds and intense ultraviolet light made the Antarctic an extremely tough test environment.

**TOUGH JUDGES**  
Operators are tough judges. They know what they like and what they don't. We've talked, we've listened and we've delivered a no-nonsense excavator that will do everything the operator wants and needs it to do. Job done? Judge for yourself.

**TOUGH EQUIPMENT**  
**50,000** Excavators currently in the field.  
 Over **1/2 BILLION** productive hours worked.





# POWER TO GET THE TOUGHEST JOBS DONE RIGHT

Fit for purpose is about giving your operators efficient and intelligent power when they need it, with control and precision. That's what we do.

## POWER WITHOUT COMPROMISE.

The 922E/925E is powered by the latest Cummins QSB6.7 engine in compliance with strict EU Stage IV emission standards. The compact QSB6.7 engine delivers unmatched and dependable power in its class yet it produces virtually zero emissions. The engine utilizes a precise and high pressure common-rail fuel injection system, turbo charger (VGT) and air-to-air intercooler along with electronic engine controls to optimize machine performance. It's powerful. It's responsive. It tackles the toughest jobs without being thirsty for fuel, but above all, it's a joy to operate.



## INTELLIGENT POWER CONTROL

The 922E/925E's advanced Intelligent Power Control (IPC) system intelligently delivers the power you need – when you need it.

This new generation computer-aided IPC system allows the 922E/925E's mechanical, electrical and hydraulic systems to work together in perfect harmony and helps even novice operators get more from the machine. An improved pump system delivers efficient oil output under lower engine speeds, resulting in fuel efficiency and reduced noise levels.

## ADVANCED HYDRAULIC SYSTEM

LiuGong's advanced hydraulic system, regenerates oil in the cylinders more efficiently reducing heat, increasing fuel efficiency and improving cycle times. The hydraulic system is highly effective in delivering power and precise control to where the operator really needs it, making even the toughest job simple.



## SMART FUEL ECONOMY (SAVE UP TO 4 L)

The intelligent combination of powerful digging force, swing torque and lifting performance make the most of every drop of fuel. The 922E/925E maximizes fuel economy by intelligently regulating its idle speed by the second.



**1 second:** If no hydraulic request signal detected from the joystick, the engine speed is automatically dropped by 100 RPM, saving 1 liter of fuel every 2 hours.



**3 seconds:** If no activity is detected over three seconds the engine speed will decrease to idle. In each case, as soon as the system detects the hydraulic signal once more, the engine will immediately return to the previous throttle speed setting. Our tests indicate that up to 4 liters of fuel can be saved on an 8-hour shift.



# DAILY CHECKS AND MAINTENANCE SHOULDN'T BE TOUGH

LiuGong excavators have been **specifically designed** for easy service and maintenance in even the most remote and harsh environments. If servicing is easy, it gets done.

## PRACTICAL SERVICING

Smart and effective design makes service and maintenance fast and simple – that's good news for operators who work in some of the toughest places on the planet.

Handrails are fitted as standard on the 950E, enabling safe and easy access to the upper structure for easy engine service and maintenance.

## ON BOARD MONITORING

With onboard monitoring, the operator can check the machine's vital signs without leaving his seat. Using the LCD display, the operator can easily check oil temperatures and pressure levels, receive service interval alerts and access other information that contributes to simple maintenance and servicing of the machine.



## EASILY ACCESSIBLE SERVICE POINTS MAKE DAILY CHECKS FAST AND EFFECTIVE

- Easily visible hydraulic oil level gauge
- Accessible, grouped filters
- Easy to replace A/C filter next to the cab door
- Maintenance free air filter

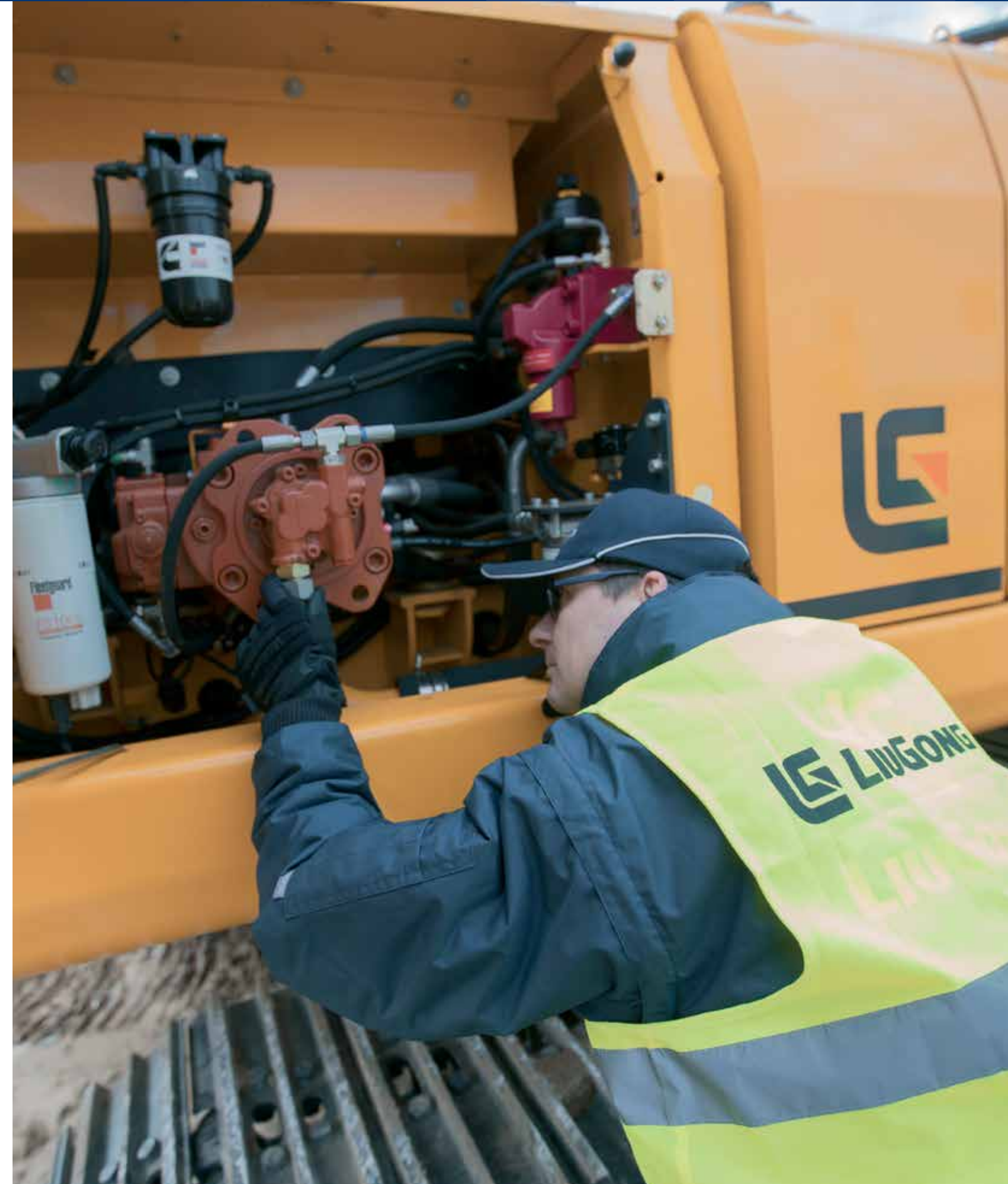





# DESIGNED TO MAKE TOUGH WORK EASY ON THE OPERATOR

Climb into the cab of the 922E/925E and you can see that it has been designed by someone who has operated a machine in really tough conditions.

For a start, it's safe and easy to get in and out of.

Trips and slips account for the majority of accidents onsite. Well-placed door handles, safety rails and anti-slip tape on the upper part of the machine make it easier and safer for operators to enter and exit the cab in all weathers and conditions.

Inside, the cab is secure and protected with space to work and excellent 360 degree views of the site.

The controls are where the operator needs them to be. They are easy to see, easy to reach and easy to handle.

The multi-adjustable air-suspension seats are comfortable and designed to keep the operator fresh and alert.

The cab is sound proofed, vibration protected and well ventilated. It has advanced climate control to handle the changing seasons and is completely sealed to prevent dust contamination.



## WE PUT OPERATORS FIRST

It makes good business sense to give operators the very best working environment – a comfortable operator is a productive operator. The 922E/925E keeps operators safer, more alert and more productive.

Smart additions such as; rear view camera, heated seats, refrigerator or personal belonging compartment and an iPod/AUX connection combine to create the best environment– for the best operators.



## ADVANCED CLIMATE CONTROL

An advanced climate control system creates the right environment in any weather.

## LARGE LCD MONITOR

The easy-to-read, full-color LCD monitor displays all the critical information your operator needs, including working mode, hydraulic oil temperature, hydraulic pressure and service intervals.







# JOBSITE UPTIME AND SUPPORT

Fit for purpose might convince you to buy your first machine, but it's uptime and support and total cost of ownership which will keep you coming back to buy more machines. Having confidence in the machine's back up and support network is a vital part of the purchasing decision. How do we at LiuGong measure up?

## FAST RESPONDING GLOBAL NETWORK

We have an extensive dealer network of over 300 dealers in more than 100 countries.

All supported by 13 regional subsidiaries and 12 regional parts depots offering expert training, parts and service support.



## WHERE YOU NEED US WHEN YOU NEED US

Reliability is built into our machines but all machines have some planned downtime. Our aim is to reduce even planned down time to the minimum by getting it right. Technician training and parts availability are also high on our agenda, as is keeping you

informed on service and maintenance work and providing clear and accurate estimates, invoices and communication. These may be small things, but customer feedback tells us that these basics really matter – so we aim to get them right.

## MAINTENANCE AND SUPPORT PACKAGES

From genuine LiuGong parts, to full repair and maintenance contracts, LiuGong has the flexibility to offer the level of support and response to suit your business and applications. Whatever level of support you choose you can be confident that it is backed up by LiuGong's service promise.

**Right parts.  
Right price.  
Right service.**

**Above all,  
we get it right  
the first time.**



### WE ARE LIUGONG. WORKING HARD TO KEEP OUR GLOBAL CUSTOMERS EARNING

9,500+  
Employees

20  
Factories

13  
Regional  
subsidiaries

300+  
Dealers

1,000+  
R&D  
engineers

5  
R&D  
facilities

12  
Regional  
parts  
depots

Over  
60 Years'  
experience

### LIUGONG SERVICE PROMISE

Highly trained technicians utilizing the latest diagnostic equipment

15,000+ Genuine LiuGong parts available within 24hrs from our European Parts Distribution Center

Multi-lingual Service helpline and online support

Transparent estimates and invoicing

Clear communications through electronic parts catalogue





# TOTAL COST OF OWNERSHIP

Fit for purpose and uptime and support are two key excavator purchasing criteria but ultimately, the machines earning potential, its overall life cost and its trade-in value really matter too.

When it comes to total cost of ownership LiuGong has a strong story to tell.

### PROFESSIONAL ADVICE

We are committed to reducing your total cost of ownership and increasing your profits. As part of this, LiuGong's experts will provide targeted advice on everything, from choosing the right machine for your needs to maximizing its efficiency on site.

### MACHINE AVAILABILITY

Our machines deliver everything you need and nothing you don't. They are expertly engineered NOT over engineered. As a result of having an extensive manufacturing operation right in the heart of Europe, we can offer significantly shorter lead times on

a range of models, compared with some manufacturers. In fact, we can deliver selected machines in as little as 4 weeks. The faster you can get a machine – the faster you can get working and earning. Our aim is to get you on to the jobsite fast.

### TICKET PRICE

At LiuGong, our aim is to provide you with real, measurable value by giving you everything you need and nothing you don't. We choose high quality, proven components and parts from world-renowned brands and suppliers.

These proven components, combined with LiuGong design and manufacturing quality, result in a high quality, competitive machine that is totally fit for purpose.

### RESIDUAL VALUE

With the combination of LiuGong design and manufacturing excellence, world class components and comprehensive uptime support, our quality holds its value.



### IT ALL ADDS UP

With the E series excavators we've risen to the challenge and given you everything you need and nothing you don't.

It's an excavator which can handle any job, anywhere, backed up by LiuGong's service promise and designed to perform on the jobsite and on the balance sheet. Add up the benefits and you'll see that 922/925E represents the formula for success.



**FIT FOR PURPOSE**

+

**UPTIME AND SUPPORT**

+

**TOTAL COST OF OWNERSHIP**

**CUSTOMER SATISFACTION**





# SPECIFICATIONS

**OPERATING WEIGHT** 922E 22,800 KG (50,265 LBS)  
925E 25,500 KG (56,218 LBS)

Operating weight includes coolant, lubricants, full fuel tank, cab, standard shoes, boom, arm, bucket and operator 75 kg (165 lbs).

**BUCKET CAPACITY** 922E 0.9-1.2 M<sup>3</sup> (1.18-1.57 YD<sup>3</sup>)  
925E 0.58 -1.4 M<sup>3</sup> (0.76 -1.83 YD<sup>3</sup>)

## ENGINE

### Description

Cummins EPA Tier 4 final / EU Stage IV, 6-cylinder straight Variable-Geometry Turbocharger (VGT), high pressure common rail, electronically controlled direct injection. Air cleaner: Cummins direct flow air filter. Cooling system: Charge air cooling.

Emission rating	EPA Tier 4 final / EU Stage IV
Engine	Cummins QSB 6.7
Aspiration	Variable-Geometry Turbocharger (VGT)
Charged air cooling	Aftercooler
Cooling fan drive	Viscous clutch
Displacement	6.7 L (1.8 gal)
Engine output - net (SAE J1349 / ISO 9249)	922E 119 kW (160 hp/162 ps) @ 2,100 rpm 925E 129 kW (173 hp/175 ps) @ 2,000 rpm
Engine output - gross (SAE J1995 / ISO 14396)	922E 129 kW (173 hp/175 ps) @ 2,100 rpm 925E 142 kW (190 hp/ 193 ps) @ 2,000 rpm
Maximum torque	922E 800 N·m (590 lbf·ft) @1,500 rpm 925E 809 N·m (597 lbf·ft) @1,500 rpm
Bore × Stroke	107 × 124 mm (4.2" × 4.9")

## ELECTRIC SYSTEM

System Voltage	24 V
Batteries	2 x 12 V
Alternator	24 V - 70 A
Start motor	922E 24 V - 7.8 kW (10.5 hp) 925E 24 V - 7.5 kW (10 hp)

## SWING SYSTEM

### Description

Planetary gear reduction driven by high torque axial piston motor, with oil disk brake. Swing parking brake resets within five seconds after swing pilot controls return to neutral.

Swing speed	922E 11.4 rpm 925E 11.6 rpm
Swing torque	922E 78,200 N·m (57,677 lbf·ft) 925E 80,800 N·m (59,595 lbf·ft)

## HYDRAULIC SYSTEM

### Main pump

Type	Two variable displacement piston pumps
Maximum flow	922E 2 × 224 L/min (2 × 59.2 gal/min) 925E 2 × 240 L/min (2 × 63.4 gal/min)

### Pilot pump

Type	Gear pump
Maximum flow	19 L/min (5 gal/min)

### Relief valve setting

Implement	34.3/37.3 MPa (4,975 / 5,410 psi)
Travel circuit	34.3 MPa (4,975 psi)
Slew circuit	25.5 MPa (3,698 psi)
Pilot circuit	3.9 MPa (566 psi)

### Hydraulic cylinders

Boom Cylinder – Bore × Stroke	922E $\Phi$ 120 × 1,335 mm ( $\Phi$ 4.7" × 4'5") 925E $\Phi$ 130 × 1,350 mm ( $\Phi$ 5.1" × 4'5")
Arm Cylinder – Bore × Stroke	922E $\Phi$ 135 × 1,490 mm ( $\Phi$ 5.3" × 4'11") 925E $\Phi$ 145 × 1,635 mm ( $\Phi$ 5.7" × 5'4")
Bucket Cylinder – Bore × Stroke	922E $\Phi$ 115 × 1,120 mm ( $\Phi$ 4.5" × 3'8") 925E $\Phi$ 130 × 1,075 mm ( $\Phi$ 5.1" × 3'6")

## SOUND PERFORMANCE

Interior Sound Power Level (ISO 6396)	922E 69 dB(A) 925E 73 dB(A)
Exterior Sound Power Level (ISO 6395)	922E 100 dB(A) 925E 102 dB(A)

## SERVICE CAPACITIES

Fuel tank	922E 420 L (111 gal) 925E 470 L (124 gal)
Engine oil	25 L (6.6 gal)
Final drive (each)	5.5 L (1.5 gal)
Swing drive	922E 3.4 L (0.9 gal) 925E 4.4 L (1.2 gal)
Cooling system	922E 25 L (6.6 gal) 925E 30 L (7.9 gal)
Hydraulic reservoir	210 L (55.5 gal)
Hydraulic system total	330 L (87.2 gal)
DEF tank	35 L (9.2 gal)

## UNDERCARRIAGE

Track shoe each side	922E 49 / 925E 51
Link pitch	190 mm (7.5")
Shoe width, triple grouser	600/700/800/900 mm (24"/28"/32"/35")
Bottom rollers each side	922E 8 925E 9
Top rollers each side	2

## DRIVE AND BRAKES

### Description

2-speed axial piston motors with oil disk brakes. Steering controlled by two hand levers with pedals.	
Max. travel speed	922E High: 5.6 km/h (3.5 mph) Low: 3.3 km/h (2.1 mph) 925E High: 6.0 km/h (3.7 mph) Low: 3.5 km/h (2.2 mph)
Gradeability	35%/70%
Max. drawbar pull	922E 220 kN (49,458 lbf) 925E 229 kN (51,481 lbf)

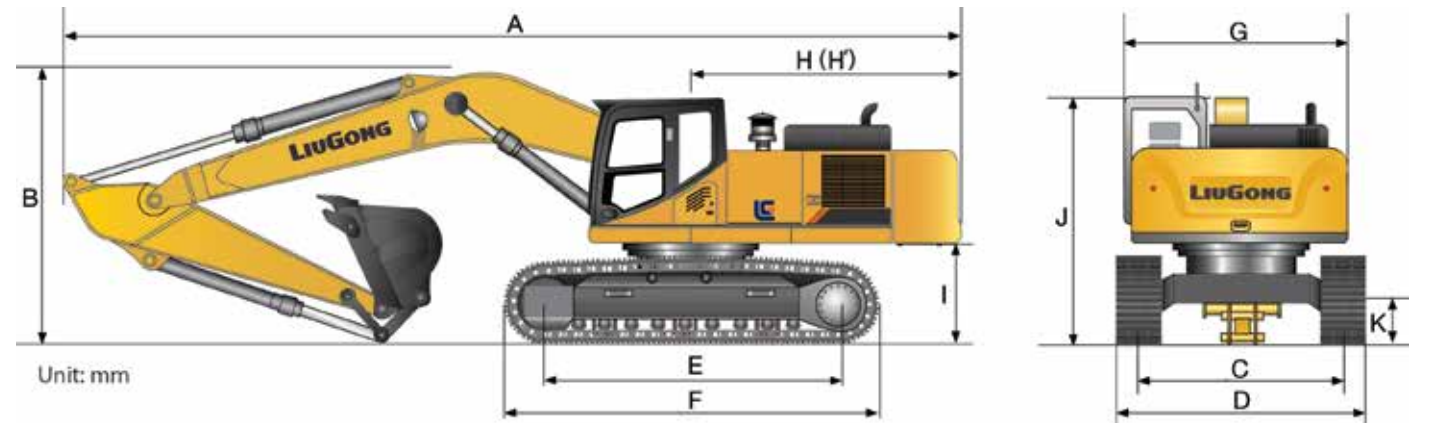

## DIMENSIONS

	922E		
Boom	5,710 mm (18'9")		8,500 mm (27'11")
Arm Options	2,915 mm (9'7")	2,700 mm (8'10")	6,400 mm (21')
A Shipping Length	9,570 mm (31'5")		12,435 mm (40'10")
B Shipping Height – Top of Boom	3,140 mm (10'4")		3,200 mm (10'6")
C Track Gauge	2,390 mm (7'10")		2,390 mm (7'10")
D Undercarriage Width – with 600 mm (24") Shoes	2,990 mm (9'10")		/
700 mm (28") Shoes	3,090 mm (10'2")		/
800 mm (32") Shoes	3,190 mm (10'6")		3,190 mm (10'6")
900 mm (35") Shoes	3,290 mm (10'10")		3,290 mm (10'10")
E Length to Center of Rollers	3,650 mm (12')		3,650 mm (12')
F Track Length	4,440 mm (14'7")		4,440 mm (14'7")
G Overall Width of Upper Structure	2,760 mm (9'1")		2,760 mm (9'1")
H Tail Swing Radius	2,780 mm (9'1")		2,780 mm (9'1")
I Counterweight Ground Clearance	1,070 mm (3'6")		1,070 mm (3'6")
J Overall Height of Cab	3,040 mm (10')		3,040 mm (10')
K Min. Ground Clearance	440 mm (1'5")		440 mm (1'5")
L Track Shoe Width	600 mm (24")		800 mm (32")

## BOOM DIMENSIONS

922E	STANDARD	LONG-REACH
Boom	5,710 mm (18'9")	8,500 mm (27'11")
Length	5,915 mm (19'5")	8,690 mm (28'6")
Height	1,550 mm (5'1")	1,585 mm (5'2")
Width	621 mm (2')	800 mm (2'7")
Weight	1,895 kg (4,178 lbs)	2,660 kg (5,864 lbs)

Cylinder, piping and pin included.  
Boom cylinder pin excluded.

## ARM DIMENSIONS

922E	STANDARD	SHORT ARM	LONG-REACH
Arm	2,915 mm (9'7")	2,700 mm (8'10")	6,400 mm (21')
Length	3,895 mm (12'9")	3,685 mm (12'1")	7,530 mm (24'7")
Height	790 mm (2'7")	810 mm (2'9")	815 mm (2'8")
Width	466 mm (1'6")	466 mm (1'6")	470 mm (1'6")
Weight	1,110 kg (2,447 lbs)	1,073 kg (2,366 lbs)	1,400 kg (3,086 lbs)

Cylinder, linkage and pin included.



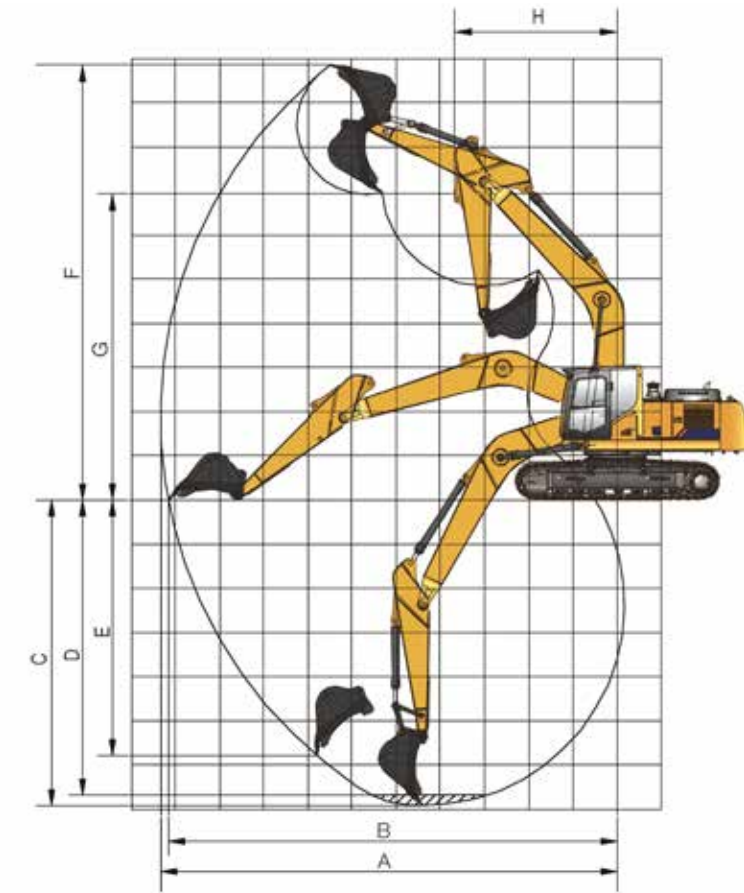
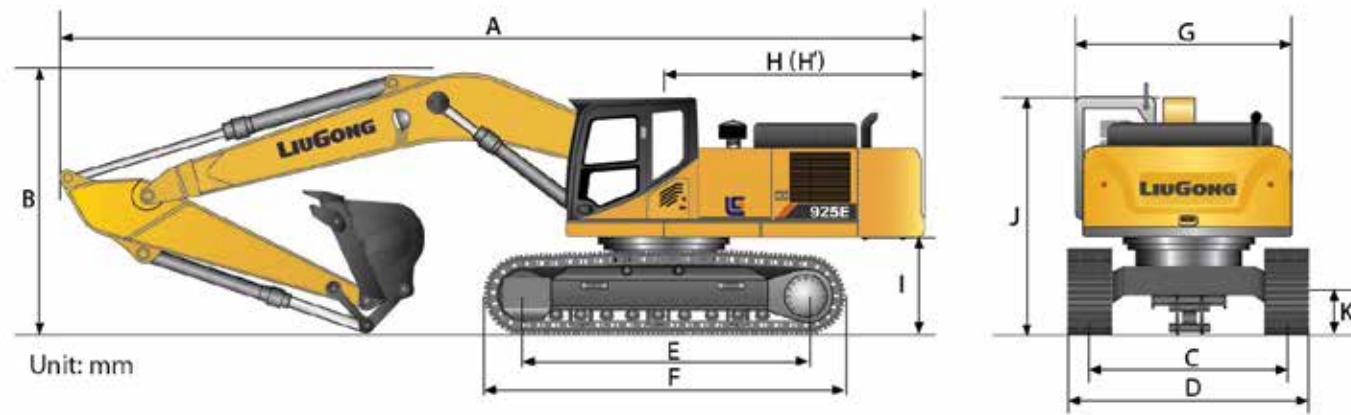

**DIMENSIONS**

	925E		
Boom	6,000 mm (19'8")	8,500 mm (27'11")	6,000 mm (19'8")
Arm Options	2,980 mm (9'9") 2,400 mm (7'10")	6,400 mm (21')	2,980 mm (9'9") 2,400 mm (7'10")
A Shipping Length	10,220 mm (33'6") 10,200 mm (33'6")	12,540 mm (41'2")	10,220 mm (33'6") 10,200 mm (33'6")
B Shipping Height – Top of Boom	3,480 mm (11'5")	3,100 mm (10'2")	3,480 mm (11'5")
C Track Gauge	2,590 mm (8'6")	2,590 mm (8'6")	2,390 mm (7'10")
D Undercarriage Width – 600 mm Shoes	3,190 mm (10'6")	-	2,990 mm (9'10")
700 mm Shoes	3,290 mm (10'10")	-	3,090 mm (10'2")
800 mm Shoes	3,390 mm (11'1")	3,390 mm (11'1")	3,190 mm (10'6")
900 mm Shoes	3,490 mm (11'5")	3,490 mm (11'5")	3,290 mm (10'10")
E Length to Center of Rollers	3,840 mm (12'7")	3,840 mm (12'7")	3,650 mm (12')
F Track Length	4,635 mm (15'2")	4,635 mm (15'2")	4,445 mm (14'7")
G Overall Width of Upper Structure	2,760 mm (9'1")	2,760 mm (9'1")	2,760 mm (9'1")
H Tail swing Radius	3,100 mm (9'11")	3,010 mm (9'11")	3,100 mm (9'11")
I Counterweight Ground Clearance	1,055 mm (3'6")	1,055 mm (3'6")	1,055 mm (3'6")
J Overall Height of Cab	3,050 mm (10')	3,050 mm (10')	3,050 mm (10')
K Min. Ground Clearance	440 mm (1'5")	440 mm (1'5")	440 mm (1'5")
L Track Shoe Width	600 mm (24")	600 mm (24")	600 mm (24")

**BOOM DIMENSIONS**

925E	STANDARD	LONG-REACH
Boom	6,000 mm (19'8")	8,500 mm (27'11")
Length	6,210 mm (20'4")	8,710 mm (28'7")
Height	1,690 mm (5'7")	1,580 mm (5'2")
Width	726 mm (2'5")	726 mm (2'5")
Weight	2,450 kg (5,401 lbs)	2,880 kg (6,349 lbs)

Includes cylinder, piping and pin, excludes boom cylinder pin.

**ARM DIMENSIONS**

925E	STANDARD	SHORT ARM	LONG-REACH
Arm	2,980 mm (9'9")	2,400 mm (7'10")	6,400 mm (21')
Length	4,060 mm (13'4")	3,490 mm (11'5")	7460 mm (24'6")
Height	885 mm (2'11")	895 mm (2'11")	850 mm (2'9")
Width	408 mm (1'4")	408 mm (1'4")	366 mm (1'2")
Weight	1,240 kg (2,734 lbs)	1,140 kg (2,513 lbs)	1,400 kg (3,086 lbs)

Includes cylinder, linkage and pin.

**WORKING RANGE**

	922E		
Boom	5,710 mm (18'9")	8,500 mm (27'11")	
Arm Options	2,915 mm (9'7") 2,700 mm (8'10")	6,400 mm (21')	
A. Max. Digging Reach	9,870 mm (32'5")	9,735 mm (31'11")	15,110 mm (49'7")
B. Max. Digging Reach on Ground	9,685 mm (31'9")	9,550 mm (31'4")	14,985 mm (49'2")
C. Max. Digging Depth	6,562 mm (21'6")	6,380 mm (20'11")	11,910 mm (39'1")
D. Max. Digging Depth, 2.44 m (8') Level	6,390 mm (21')	6,140 mm (20'2")	11,785 mm (38'8")
E. Max. Vertical Wall Digging Depth	5,080 mm (16'8")	5,040 mm (16'6")	5,395 mm (17'8")
F. Max. Cutting Height	9,945 mm (32'8")	9,970 mm (32'9")	12,780 mm (41'11")
G. Max. Dumping Height	7,170 mm (23'6")	7,200 mm (23'7")	10,535 mm (34'7")
H. Min. Front Swing Radius	3,090 mm (10'2")	3,120 mm (10'3")	4,270 mm (14')
Bucket Digging Force (ISO)	Normal	140 kN (31,473 lbf)	140 kN (31,473 lbf) 55 kN (12,364 lbf)
	Power Boost	152 kN (34,171 lbf)	152 kN (34,171 lbf) 60 kN (13,489 lbf)
Arm Digging Force (ISO)	Normal	97 kN (21,806 lbf)	102 kN (22,931 lbf) 70 kN (15,737 lbf)
	Power Boost	105 kN (23,605 lbf)	110.5 kN (24,841 lbf) 76 kN (17,085 lbf)
Bucket Capacity	1.0 m <sup>3</sup> (1.31 yd <sup>3</sup> )	1.1 m <sup>3</sup> (1.44 yd <sup>3</sup> )	0.45 m <sup>3</sup> (0.59 yd <sup>3</sup> )
Bucket Tip Radius	1,450 mm (4'9")	1,450 mm (4'9")	1,250 mm (4'1")



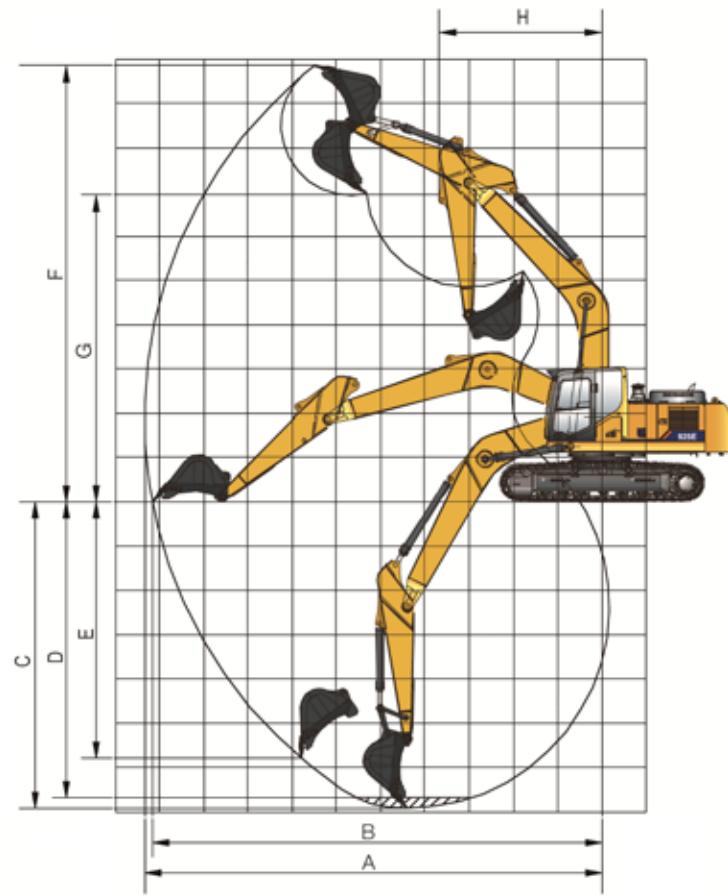

**WORKING RANGE**

		925E			
		6,000 mm (19'8")	8,500 mm (27'11")	6,000 mm (19'8")	
Boom					
Arm Options		2,980 mm (9'9")	2,400 mm (7'10")	6,400 mm (21')	2,980 mm (9'9")
A. Max. Digging Reach		10,340 mm (33'11")	9,900 mm (32'6")	15,720 mm (51'7")	10,340 mm (33'11")
B. Max. Digging Reach on Ground		10,150 mm (33'4")	9,715 mm (31'10")	15,620 mm (51'3")	10,150 mm (33'4")
C. Max. Digging Depth		6,925 mm (22'9")	6,340 mm (20'10")	11,720 mm (38'5")	6,925 mm (22'9")
D. Max. Digging Depth, 2.44 m (8') Level		6,675 mm (21'11")	6,120 mm (20'1")	11,620 mm (38'1")	6,675 mm (21'11")
E. Max. Vertical Wall Digging Depth		5,795 mm (19')	5,445 mm (17'10")	10,400 mm (34'1")	5,795 mm (19')
F. Max. Cutting Height		9,940 mm (32'7")	9,745 mm (32')	14,410 mm (47'3")	9,940 mm (32'7")
G. Max. Dumping Height		6,920 mm (22'8")	6,695 mm (22')	12,030 mm (39'6")	6,920 mm (22'8")
H. Min. Front Swing Radius		3,695 mm (12'1")	3,860 mm (12'8")	4,300 mm (14'1")	3,695 mm (12'1")
Bucket Digging Force (ISO)		165 kN (37,093 lbf)	142 kN (31,923 lbf)	89 kN (20,008 lbf)	165 kN (37,093 lbf)
		179 kN (40,241 lbf)	154 kN (34,621 lbf)	-	179 kN (40,241 lbf)
Arm Digging Force (ISO)		124 kN (27,876 lbf)	136 kN (30,574 lbf)	62 kN (13,938 lbf)	124 kN (27,876 lbf)
		134 kN (30,124 lbf)	148 kN (33,272 lbf)	-	134 kN (30,124 lbf)
Bucket Capacity		1.2 m <sup>3</sup> (1.57 yd <sup>3</sup> )	1.4 m <sup>3</sup> (1.83 yd <sup>3</sup> )	0.58 m <sup>3</sup> (0.76 yd <sup>3</sup> )	1.1 m <sup>3</sup> (1.44 yd <sup>3</sup> )
Bucket Tip Radius		1,540 mm (5'1")	1,250 mm (4'1")		1,540 mm (5'1")

**BUCKET SELECTION GUIDE**

		922E						
					5.7 m (18'9") boom		8.5 m (27'11") boom	
Bucket type	Capacity	Cutting width	Weight	Teeth pcs	2.9 m (9'7") arm	2.7 m (8'10") arm	6.4 m (21') arm	
General purpose	0.45 m <sup>3</sup> (0.59 yd <sup>3</sup> )	865 mm (2'10")	372 kg (820 lbs)	4	NA	NA	A	
Heavy duty	0.9 m <sup>3</sup> (1.18 yd <sup>3</sup> )	1,083 mm (3'7")	786 kg (1,733 lbs)	5	B	B	NA	
General purpose	0.95 m <sup>3</sup> (1.24 yd <sup>3</sup> )	1,268 mm (4'2")	769 kg (1,695 lbs)	5	B	B	NA	
Heavy duty	1 m <sup>3</sup> (1.31 yd <sup>3</sup> )	1,113 mm (3'8")	887 kg (1,956 lbs)	5	B	B	NA	
Wide and shallow bucket	1 m <sup>3</sup> (1.31 yd <sup>3</sup> )	1,227 mm (4')	850 kg (1,874 lbs)	5	A	A	NA	
Super heavy duty	1 m <sup>3</sup> (1.31 yd <sup>3</sup> )	1,280 mm (4'2")	905 kg (1,995 lbs)	5	C	C	NA	
Heavy duty	1.1 m <sup>3</sup> (1.44 yd <sup>3</sup> )	1,330 mm (4'4")	852 kg (1,878 lbs)	6	B	B	NA	
Heavy duty	1.2 m <sup>3</sup> (1.57 yd <sup>3</sup> )	1,420 mm (4'8")	915 kg (2,017 lbs)	6	A	A	NA	

The recommendations are given as a guide only, based on typical operation conditions. Bucket capacity based on ISO 7451, heaped material with a 1:1 angle of repose.

Maximum material density:  
 A 1,200 - 1,300 kg/m<sup>3</sup> (2,023 - 2,191 lb/yd<sup>3</sup>): Coal, Caliche, Shale  
 B 1,400 - 1,600 kg/m<sup>3</sup> (2,360 - 2,697 lb/yd<sup>3</sup>): Wet earth and clay, limestone, sandstone  
 C 1,700 - 1,800 kg/m<sup>3</sup> (2,865-3,034 lb/yd<sup>3</sup>): Granite, wet sand, well blasted rock  
 D 1,900 kg/m<sup>3</sup> (3,203 lb/yd<sup>3</sup>): Wet mud, Iron ore  
 NA. Not applicable

**MACHINE WEIGHTS AND GROUND PRESSURE**

		922E					
		Operating weight		Ground pressure		Overall width	
Shoe width		5.7 m (18'9") boom, 2.9 m (9'7") arm, 1.0 m <sup>3</sup> (1.3 yd <sup>3</sup> ) bucket, 4,000 kg (8,818 lbs) counterweight			5.7 m (18'9") boom, 2.7 m (8'10") arm, 1.1 m <sup>3</sup> (1.44 yd <sup>3</sup> ) bucket, 4,000 kg (8,818 lbs) counterweight		
600 mm (24")		22,800 kg (50,265 lbs)	46.9 kPa (6.8 psi)	2,990 mm (9'10")	22,800 kg (50,265 lbs)	46.9 kPa (6.8 psi)	2,990 mm (9'10")
700 mm (28")		23,080 kg (50,883 lbs)	40.7 kPa (5.9 psi)	3,090 mm (10'2")	23,080 kg (50,883 lbs)	40.7 kPa (5.9 psi)	3,090 mm (10'2")
800 mm (32")		23,370 kg (51,522 lbs)	36 kPa (5.2 psi)	3,190 mm (10'6")	23,370 kg (51,522 lbs)	36 kPa (5.2 psi)	3,190 mm (10'6")
900 mm (35")		23,650 kg (52,139 lbs)	32.4 kPa (4.7 psi)	3,290 mm (10'10")	23,650 kg (52,139 lbs)	32.4 kPa (4.7 psi)	3,290 mm (10'10")

**MACHINE WEIGHTS AND GROUND PRESSURE**

		922E LONG REACH		
		Operating weight		Overall width
Shoe width		8.5 m (27'11") boom, 6.4 m (21') arm, 0.45 m <sup>3</sup> (0.59 yd <sup>3</sup> ) bucket, 5,000 kg (11,023 lbs) counterweight		
800 mm (32")		24,650 kg (54,344 lbs)	38.0 kPa (5.5 psi)	3,190 mm (10'6")
900 mm (35")		24,930 kg (54,961 lbs)	34.2 kPa (5.0 psi)	3,290 mm (10'10")





**BUCKET SELECTION GUIDE**

		925E								
Bucket type	Capacity	Cutting width	Weight	Teeth PCS	6.0 m (19'8") HD Boom				8.5 m (27'11")	
					2.98 m (9'9")	2.4 m (7'10")	2.98 m (9'9")	2.4 m (7'10")	6.4 m (21')	
General purpose	0.58 m³ (0.76 yd³)	990 mm (3'3")	500 kg (1,102 lbs)	5	NA	NA	NA	NA	NA	B
Heavy duty	1.1 m³ (1.44 yd³)	1,265 mm (4'2")	1,000 kg (2,205 lbs)	5	D	D	C	D	NA	NA
General purpose	1.2 m³ (1.57 yd³)	1,380 mm (4'6")	990 kg (2,183 lbs)	5	B	NA	B	NA	NA	NA
Heavy duty	1.2 m³ (1.57 yd³)	1,380 mm (4'6")	1,050 kg (2,315 lbs)	5	C	D	B	D	NA	NA
General purpose	1.3 m³ (1.70 yd³)	1,235 mm (4'1")	1,100 kg (2,425 lbs)	5	B	D	NA	C	NA	NA
Heavy duty	1.4 m³ (1.83 yd³)	1,460 mm (4'9")	1,150 kg (2,535 lbs)	5	NA	C	NA	B	NA	NA

The recommendations are given as a guide only, based on typical operation conditions. Bucket capacity based on ISO 7451, heaped material with a 1:1 angle of repose.

Maximum material density:  
 A 1,200 - 1,300 kg/m³ (2,023 - 2,191 lb/yd³): Coal, Caliche, Shale  
 B 1,400 - 1,600 kg/m³ (2,360 - 2,697 lb/yd³): Wet earth and clay, limestone, sandstone  
 C 1,700 - 1,800 kg/m³ (2,865 - 3,034 lb/yd³): Granite, wet sand, well blasted rock  
 D 1,900 kg/m³ (3,203 lb/yd³): Wet mud, Iron ore  
 NA. Not applicable

**MACHINE WEIGHTS AND GROUND PRESSURE**

925E						
Shoe width	Operating weight	Ground pressure	Overall width	Operating weight	Ground pressure	Overall width
	6.0 m (19'8") boom, 2.98 m (9'9") arm, 1.2 m³ (1.57 yd³) bucket, 5,000 kg (11,023 lbs) counterweight			6.0 m (19'8") boom, 2.4 m (7'10") arm, 1.4 m³ (1.83 yd³) bucket, 5,000 kg (11,023 lbs) counterweight		
600 mm (24")	25,500 kg (56,218 lbs)	50.5 kPa (7.3 psi)	3,190 mm (10'6")	25,500 kg (56,218 lbs)	50.5 kPa (7.3 psi)	3,190 mm (10'6")
700 mm (28")	25,800 kg (56,879 lbs)	43.8 kPa (6.4 psi)	3,290 mm (10'10")	25,800 kg (56,879 lbs)	43.8 kPa (6.4 psi)	3,290 mm (10'10")
800 mm (32")	26,100 kg (57,541 lbs)	38.8 kPa (5.6 psi)	3,390 mm (11'1")	26,100 kg (57,541 lbs)	38.8 kPa (5.6 psi)	3,390 mm (11'1")
900 mm (35")	26,400 kg (58,202 lbs)	34.9 kPa (5.1 psi)	3,490 mm (11'5")	26,400 kg (58,202 lbs)	34.9 kPa (5.1 psi)	3,490 mm (11'5")

925E LONG REACH			
Shoe width	Operating weight	Ground pressure	Overall width
	8.5 m (27'11") boom, 6.4 m (21') arm, 0.58 m³ (0.76 yd³) bucket, 6,800 kg (14,991 lbs) counterweight		
800 mm (32")	27,900 kg (61,509 lbs)	41.4 kPa (6.0 psi)	3,390 mm (11'1")
900 mm (35")	28,200 kg (62,170 lbs)	37.2 kPa (5.4 psi)	3,490 mm (11'5")

925E NARROW						
Shoe width	Operating weight	Ground pressure	Overall width	Operating weight	Ground pressure	Overall width
	6.0 m (19'8") boom, 2.98 m (9'9") arm, 1.1 m³ (1.44 yd³) bucket, 5,000 kg (11,023 lbs) counterweight			6.0 m (19'8") boom, 2.4 m (7'10") arm, 1.3 m³ (1.7 yd³) bucket, 5,000 kg (11,023 lbs) counterweight		
600 mm (24")	25,000 kg (55,116 lbs)	51.9 kPa (7.5 psi)	2,990 mm (9'10")	25,000 kg (55,116 lbs)	51.9 kPa (7.5 psi)	2,990 mm (9'10")
700 mm (28")	25,300 kg (55,777 lbs)	45 kPa (6.5 psi)	3,090 mm (10'2")	25,300 kg (55,777 lbs)	45 kPa (6.5 psi)	3,090 mm (10'2")
800 mm (32")	25,600 kg (56,438 lbs)	39.8 kPa (5.8 psi)	3,190 mm (10'6")	25,600 kg (56,438 lbs)	39.8 kPa (5.8 psi)	3,190 mm (10'6")
900 mm (35")	25,900 kg (57,100 lbs)	35.8 kPa (5.2 psi)	3,290 mm (10'10")	25,900 kg (57,100 lbs)	35.8 kPa (5.2 psi)	3,290 mm (10'10")

Lifting capacity at the arm end without bucket.  
 For lifting capacity including bucket, weight of the bucket or the bucket with quick coupler must be deducted from the lifting capacities.  
 Lifting capacities are based on the machine standing on a firm, uniform supporting surface.



Rating over - front (Cf) Rating over - side (Cs)

- Do not attempt to lift or hold any load that is greater than these rated values at their specified load radius and height. Weight of all accessories must be deducted from the above lifting capacities.
- The rated loads are in compliance with ISO 10567 Hydraulic Excavator Lift Capacity Rating Standard. They do not exceed 87% of hydraulic lifting capacity or 75% tipping load.
- Ratings at bucket lift hook.
- Lifting capacities are based on machine standing on level, firm and uniform ground.
- \*Indicates the load is limited by hydraulic capacity rather than tipping capacity.
- Operator should be fully acquainted with the Operator's and Maintenance Instructions before operating this machine and rules for the safe operation of equipment should be adhered to at all times.

**LIFTING CAPACITY (METRIC)**

922E with 600 mm shoes, 2,700 mm arm

A: Load radius  
 B: Load point height  
 C: Lifting capacity  
 Cf: Rating over front  
 Cs: Rating over side

Conditions

Boom length: 5,710 mm  
 Arm length: 2,700 mm  
 Bucket: None  
 Counterweight: 4,000 kg  
 Shoes: 600 mm triple grouser  
 Unit: kg

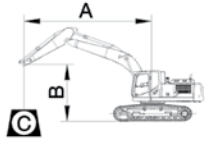

B (m)	A (Unit: m)										
	3		4.5		6		7.5		MAX REACH		A (m)
7.5											
6.0					*4,430	*4,430			*4,430	*4,430	7.1
4.5			*7,360	*7,360	*6,420	5,710	*6,070	4,130	*4,310	3,880	7.8
3.0			*9,530	8,160	*7,410	5,500	6,280	4,040	*4,040	3,560	8.2
1.5			*11,460	7,750	*8,410	5,290	6,170	3,950	*5,050	3,500	8.2
GROUND LEVEL			*12,440	7,540	8,370	5,160	6,100	3,880	*5,540	3,570	8.0
-1.5	*12,440	*12,440	*12,500	7,500	8,310	5,110	6,090	3,870	6,090	3,870	7.5
-3.0	*16,480	14,170	*11,690	7,570	8,370	5,150			7,320	4,590	6.6
-4.5	*13,170	*13,170	*9,400	7,780					*8,050	6,580	5.1

922E with 700 mm shoes, 2,700 mm arm

A: Load radius  
 B: Load point height  
 C: Lifting capacity  
 Cf: Rating over front  
 Cs: Rating over side

Conditions

Boom length: 5,710 mm  
 Arm length: 2,700 mm  
 Bucket: None  
 Counterweight: 4,000 kg  
 Shoes: 700 mm triple grouser  
 Unit: kg

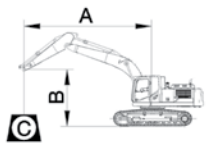

B (m)	A (Unit: m)										
	3		4.5		6		7.5		MAX REACH		A (m)
7.5	Cf	Cs	Cf	Cs	Cf	Cs	Cf	Cs	Cf	Cs	
6.0					*4,430	*4,430			*4,430	*4,430	7.1
4.5			*7,360	*7,360	*6,420	5,800	*6,070	4,200	*4,310	3,960	7.8
3.0			*9,530	8,310	*7,410	5,590	6,390	4,120	*4,040	3,620	8.2
1.5			*11,460	7,890	*8,410	5,390	6,280	4,020	*5,050	3,570	8.2
GROUND LEVEL			*12,440	7,680	8,520	5,260	6,210	3,950	*5,540	3,640	8.0
-1.5	*12,440	*12,440	*12,500	7,640	8,460	5,210	6,190	3,940	6,190	3,940	7.5
-3.0	*16,480	14,430	*11,690	7,710	8,510	5,250			7,450	4,670	6.6
-4.5	*13,170	*13,170	*9,400	7,930					*8,050	6,700	5.1





**LIFTING CAPACITY (IMPERIAL)**

922E with 24" shoes, 8'10" arm

Conditions

Boom length: 18'9"  
 Arm length: 8'10"  
 Bucket: None  
 Counterweight: 8,818 lb  
 Shoes: 24" triple grouser  
 Unit: lbs

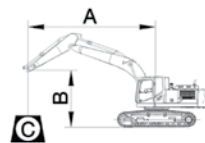

A: Load radius  
 B: Load point height  
 C: Lifting capacity  
 Cf: Rating over front  
 Cs: Rating over side

B (ft)	A (Unit: ft)										
	10		15		20		25		MAX REACH		A (ft)
	Cf	Cs	Cf	Cs	Cf	Cs	Cf	Cs	Cf	Cs	
25					*9,766	*9,766			*9,766	*9,766	19.7
20					*12,764	*12,764			*9,700	*9,700	23.3
15			*16,226	*16,226	*14,153	12,588	*13,382	9,105	*9,501	8,553	25.6
10			*21,010	17,989	*16,336	12,125	13,845	8,906	*8,906	7,848	26.9
5			*25,264	17,085	*18,540	11,662	13,602	8,708	*11,133	7,716	26.9
GROUND LEVEL			*27,425	16,622	18,452	11,375	13,448	8,553	*12,213	7,870	26.2
-5	*27,425	*27,425	*27,557	16,534	18,320	11,265	13,426	8,531	13,426	8,531	24.6
-10	*36,332	31,239	*25,772	16,688	18,452	11,353			16,137	10,119	21.7
-15	*29,034	*29,034	*20,723	17,151					*17,747	14,506	16.7

922E with 28" shoes, 8'10" arm

Conditions

Boom length: 18'9"  
 Arm length: 8'10"  
 Bucket: None  
 Counterweight: 8,818 lb  
 Shoes: 28" triple grouser  
 Unit: lbs

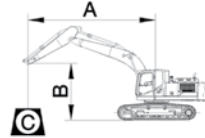

A: Load radius  
 B: Load point height  
 C: Lifting capacity  
 Cf: Rating over front  
 Cs: Rating over side

B (ft)	A (Unit: ft)										
	10		15		20		25		MAX REACH		A (ft)
	Cf	Cs	Cf	Cs	Cf	Cs	Cf	Cs	Cf	Cs	
25					*9,766	*9,766			*9,766	*9,766	19.7
20					*12,764	*12,764			*9,700	*9,700	23.3
15			*16,226	*16,226	*14,153	12,786	*13,382	9,259	*9,501	8,730	25.6
10			*21,010	18,320	*16,336	12,323	14,087	9,083	*8,906	7,980	26.9
5			*25,264	17,394	*18,540	11,882	13,845	8,862	*11,133	7,870	26.9
GROUND LEVEL			*27,425	16,931	18,783	11,596	13,690	8,708	*12,213	8,024	26.2
-5	*27,425	*27,425	*27,557	16,843	18,651	11,486	13,646	8,686	13,646	8,686	24.6
-10	*36,332	31,812	*25,772	16,997	18,761	11,574			16,424	10,295	21.7
-15	*29,034	*29,034	*20,723	17,482					*17,747	14,770	16.7

**LIFTING CAPACITY (METRIC)**

922E with 800 mm shoes, 2,700 mm arm

Conditions

Boom length: 5,710 mm  
 Arm length: 2,700 mm  
 Bucket: None  
 Counterweight: 4,000 kg  
 Shoes: 800 mm triple grouser  
 Unit: kg

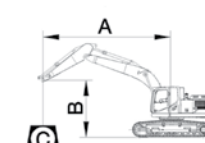

A: Load radius  
 B: Load point height  
 C: Lifting capacity  
 Cf: Rating over front  
 Cs: Rating over side

B (m)	A (Unit: m)										
	3		4.5		6		7.5		MAX REACH		A (m)
	Cf	Cs	Cf	Cs	Cf	Cs	Cf	Cs	Cf	Cs	
7.5					*4,430	*4,430			*4,430	*4,430	6.0
6.0					*5,790	*5,790			*4,400	*4,400	7.1
4.5			*7,360	*7,360	*6,420	5,890	*6,070	4,270	*4,310	4,020	7.8
3.0			*9,530	8,430	*7,410	5,680	*6,480	4,180	*4,040	3,690	8.2
1.5			*11,460	8,020	*8,410	5,480	6,380	4,090	*5,050	3,630	8.2
GROUND LEVEL			*12,440	7,810	8,650	5,340	6,300	4,020	*5,540	3,700	8.0
-1.5	*12,440	*12,440	*12,500	7,770	8,590	5,290	6,290	4,010	6,290	4,010	7.5
-3.0	*16,480	14,660	*11,690	7,840	8,650	5,340			7,560	4,750	6.6
-4.5	*13,170	*13,170	*9,400	8,060					*8,050	6,810	5.1

922E with 900 mm shoes, 2,700 mm arm

Conditions

Boom length: 5,710 mm  
 Arm length: 2,700 mm  
 Bucket: None  
 Counterweight: 4,000 kg  
 Shoes: 900 mm triple grouser  
 Unit: kg

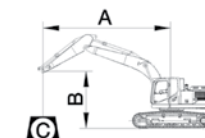

A: Load radius  
 B: Load point height  
 C: Lifting capacity  
 Cf: Rating over front  
 Cs: Rating over side

B (m)	A (Unit: m)										
	3		4.5		6		7.5		MAX REACH		A (m)
	Cf	Cs	Cf	Cs	Cf	Cs	Cf	Cs	Cf	Cs	
7.5					*4,430	*4,430			*4,430	*4,430	6.0
6.0					*5,790	*5,790			*4,400	*4,400	7.1
4.5			*7,360	*7,360	*6,420	5,980	*6,070	4,340	*4,310	4,090	7.8
3.0			*9,530	8,570	*7,410	5,780	*6,480	4,250	*4,040	3,750	8.2
1.5			*11,460	8,150	*8,410	5,570	6,480	4,160	*5,050	3,690	8.2
GROUND LEVEL			*12,440	7,940	8,790	5,440	6,400	4,090	*5,540	3,770	8.0
-1.5	*12,440	*12,440	*12,500	7,900	8,730	5,380	*6,380	4,080	*6,380	4,080	7.5
-3.0	*16,480	14,910	*11,690	7,970	*8,700	5,430			*7,660	4,830	6.6
-4.5	*13,170	*13,170	*9,400	8,190					*8,050	6,930	5.1





**LIFTING CAPACITY (IMPERIAL)**

922E with 32" shoes, 8'10" arm

Conditions

Boom length: 18'9"  
 Arm length: 8'10"  
 Bucket: None  
 Counterweight: 8,818 lb  
 Shoes: 32" triple grouser  
 Unit: lbs

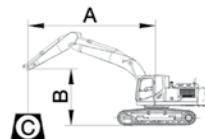

A: Load radius  
 B: Load point height  
 C: Lifting capacity  
 Cf: Rating over front  
 Cs: Rating over side

B (ft)	A (Unit: ft)										A (ft)
	10		15		20		25		MAX REACH		
25					*9,766	*9,766			*9,766	*9,766	19.7
20					*12,764	*12,764			*9,700	*9,700	23.3
15			*16,226	*16,226	*14,153	12,985	*13,382	9,413	*9,501	8,862	25.6
10			*21,010	18,584	*16,336	12,522	*14,285	9,215	*8,906	8,135	26.9
5			*25,264	17,681	*18,540	12,081	14,065	9,016	*11,133	8,002	26.9
GROUND LEVEL			*27,425	17,218	19,069	11,772	13,889	8,862	*12,213	8,157	26.2
-5	*27,425	*27,425	*27,557	17,129	18,937	11,662	13,867	8,840	13,867	8,840	24.6
-10	*36,332	32,319	*25,772	17,284	19,069	11,772			16,666	10,471	21.7
-15	*29,034	*29,034	*20,723	17,769					*17,747	15,013	16.7

922E with 35" shoes, 8'10" arm

Conditions

Boom length: 18'9"  
 Arm length: 8'10"  
 Bucket: None  
 Counterweight: 8,818 lb  
 Shoes: 35" triple grouser  
 Unit: lbs

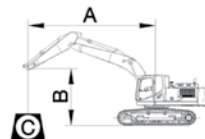

A: Load radius  
 B: Load point height  
 C: Lifting capacity  
 Cf: Rating over front  
 Cs: Rating over side

B (ft)	A (Unit: ft)										A (ft)
	10		15		20		25		MAX REACH		
25					*9,766	*9,766			*9,766	*9,766	19.7
20					*12,764	*12,764			*9,700	*9,700	23.3
15			*16,226	*16,226	*14,153	13,183	*13,382	9,568	*9,501	9,016	25.6
10			*21,010	18,893	*16,336	12,742	*14,285	9,369	*8,906	8,267	26.9
5			*25,264	17,967	*18,540	12,279	14,285	9,171	*11,133	8,135	26.9
GROUND LEVEL			*27,425	17,504	19,378	11,993	14,109	9,016	*12,213	8,311	26.2
-5	*27,425	*27,425	*27,557	17,416	19,246	11,860	*14,065	8,994	*14,065	8,994	24.6
-10	*36,332	32,870	*25,772	17,570	*19,180	11,971			*16,887	10,648	21.7
-15	*29,034	*29,034	*20,723	18,055					*17,747	15,278	16.7

**LIFTING CAPACITY (METRIC)**

922E with 600 mm shoes, 2,915 mm arm

Conditions

Boom length: 5,710 mm  
 Arm length: 2,915 mm  
 Bucket: None  
 Counterweight: 4,000 kg  
 Shoes: 600 mm triple grouser  
 Unit: kg

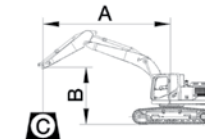

A: Load radius  
 B: Load point height  
 C: Lifting capacity  
 Cf: Rating over front  
 Cs: Rating over side

B (m)	A (Unit: m)										A (m)				
	1.5		3		4.5		6		7.5			MAX REACH			
7.5							*5,260	*5,260			*4,480	*4,480	6.2		
6.0							*5,550	*5,550			*4,270	*4,270	7.3		
4.5					*7,000	*7,000	*6,200	5,730	*5,880	4,150	*4,700	3,830	7.9		
3.0					*9,150	8,190	*7,200	5,510	6,290	4,050	*4,580	3,500	8.3		
1.5					*11,140	7,730	*8,220	5,280	6,170	3,940	*4,650	3,380	8.4		
GROUND LEVEL					*7,320	*7,320	*12,250	7,480	8,340	5,130	6,080	3,860	*5,130	3,450	8.2
-1.5	*7,950	*7,950	*12,140	*12,140	*12,450	7,420	8,270	5,060	6,060	3,830	5,950	3,770	7.6		
-3.0	*12,810	*12,810	*16,800	13,970	*11,800	7,480	8,310	5,100			6,980	4,380	6.8		
-4.5			*13,780	*13,780	*9,830	7,680					7,910	7,680	5.4		

922E with 700 mm shoes, 2,915 mm arm

Conditions

Boom length: 5,710 mm  
 Arm length: 2,915 mm  
 Bucket: None  
 Counterweight: 4,000 kg  
 Shoes: 700 mm triple grouser  
 Unit: kg

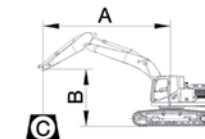

A: Load radius  
 B: Load point height  
 C: Lifting capacity  
 Cf: Rating over front  
 Cs: Rating over side

B (m)	A (Unit: m)										A (m)				
	1.5		3		4.5		6		7.5			MAX REACH			
7.5							*5,260	*5,260			*4,480	*4,480	6.2		
6.0							*5,550	*5,550			*4,270	*4,270	7.3		
4.5					*7,000	*7,000	*6,200	5,830	*5,880	4,220	*4,700	3,900	7.9		
3.0					*9,150	8,340	*7,200	5,610	*6,320	4,120	*4,580	3,570	8.3		
1.5					*11,140	7,870	*8,220	5,380	6,280	4,010	*4,650	3,450	8.4		
GROUND LEVEL					*7,320	*7,320	*12,250	7,620	8,490	5,230	6,190	3,930	*5,130	3,510	8.2
-1.5	*7,950	*7,950	*12,140	*12,140	*12,450	7,560	8,420	5,160	6,170	3,910	6,060	3,850	7.6		
-3.0	*12,810	*12,810	*16,800	14,230	*11,800	7,620	8,460	5,200			7,100	4,460	6.8		
-4.5			*13,780	*13,780	*9,830	7,830					*7,910	6,150	5.4		





**LIFTING CAPACITY (IMPERIAL)**

922E with 24" shoes, 9'7" arm

Conditions

Boom length: 18'9"  
 Arm length: 9'7"  
 Bucket: None  
 Counterweight: 8,818 lb  
 Shoes: 24" triple grouser  
 Unit: lbs

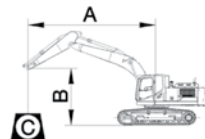

A: Load radius  
 B: Load point height  
 C: Lifting capacity  
 Cf: Rating over front  
 Cs: Rating over side

B (ft)	A (Unit: ft)												A (ft)
	5		10		15		20		25		MAX REACH		
25							*11,596	*11,596			*9,876	*9,876	20.3
20							*12,235	*12,235			*9,413	*9,413	24.0
15					*15,432	*15,432	*13,668	12,632	*12,963	9,149	*10,361	8,443	25.9
10					*20,172	18,055	*15,873	12,147	13,867	8,928	*10,097	7,716	27.2
5					*24,559	17,041	*18,121	11,640	13,602	8,686	*10,251	7,451	27.6
GROUND LEVEL			*16,137	*16,137	*27,006	16,490	18,386	11,309	13,404	8,509	*11,309	7,605	26.9
- 5	*17,526	*17,526	*26,764	*26,764	*27,447	16,358	18,232	11,155	13,360	8,443	13,117	8,311	24.9
- 10	*28,241	*28,241	*37,037	30,798	*26,014	16,490	18,320	11,243			15,388	9,656	22.3
- 15			*30,379	*30,379	*21,671	16,931					17,438	16,931	17.7

922E with 28" shoes, 9'7" arm

Conditions

Boom length: 18'9"  
 Arm length: 9'7"  
 Bucket: None  
 Counterweight: 8,818 lb  
 Shoes: 28" triple grouser  
 Unit: lbs

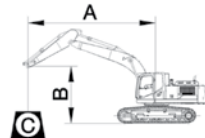

A: Load radius  
 B: Load point height  
 C: Lifting capacity  
 Cf: Rating over front  
 Cs: Rating over side

B (ft)	A (Unit: ft)												A (ft)
	5		10		15		20		25		MAX REACH		
25							*11,596	*11,596			*9,876	*9,876	20.3
20							*12,235	*12,235			*9,413	*9,413	24.0
15					*15,432	*15,432	*13,668	12,852	*12,963	9,303	*10,361	8,598	25.9
10					*20,172	18,386	*15,873	12,367	*13,933	9,083	*10,097	7,870	27.2
5					*24,559	17,350	*18,121	11,860	13,845	8,840	*10,251	7,605	27.6
GROUND LEVEL			*16,137	*16,137	*27,006	16,799	18,717	11,530	13,646	8,664	*11,309	7,738	26.9
- 5	*17,526	*17,526	*26,764	*26,764	*27,447	16,666	18,562	11,375	13,602	8,620	13,360	8,487	24.9
- 10	*28,241	*28,241	*37,037	31,371	*26,014	16,799	18,651	11,464			15,652	9,832	22.3
- 15			*30,379	*30,379	*21,671	17,262					*17,438	13,558	17.7

**LIFTING CAPACITY (METRIC)**

922E with 800 mm shoes, 2,915 mm arm

Conditions

Boom length: 5,710 mm  
 Arm length: 2,915 mm  
 Bucket: None  
 Counterweight: 4,000 kg  
 Shoes: 800 mm triple grouser  
 Unit: kg

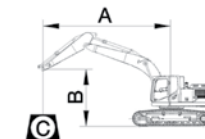

A: Load radius  
 B: Load point height  
 C: Lifting capacity  
 Cf: Rating over front  
 Cs: Rating over side

B (m)	A (Unit: m)												A (m)		
	1.5		3		4.5		6		7.5		MAX REACH				
7.5							*5,260	*5,260			*4,480	*4,480	6.2		
6.0							*5,550	*5,550			*4,270	*4,270	7.3		
4.5							*7,000	*7,000	*6,200	5,920	*5,880	4,290	*4,700	3,970	7.9
3.0							*9,150	8,460	*7,200	5,690	*6,320	4,190	*4,580	3,630	8.3
1.5							*11,140	8,000	*8,220	5,470	6,380	4,080	*4,650	3,510	8.4
GROUND LEVEL			*7,320	*7,320	*12,250	7,750	8,620	5,310	6,290	4,000	*5,130	3,570	8.2		
-1.5	*7,950	*7,950	*12,140	*12,140	*12,450	7,690	8,550	5,250	6,260	3,980	6,150	3,920	7.6		
-3.0	*12,810	*12,810	*16,800	14,470	*11,800	7,750	8,590	5,280			7,210	4,540	6.8		
-4.5			*13,780	*13,780	*9,830	7,960					*7,910	6,250	5.4		

922E with 900 mm shoes, 2,915 mm arm

Conditions

Boom length: 5,710 mm  
 Arm length: 2,915 mm  
 Bucket: None  
 Counterweight: 4,000 kg  
 Shoes: 900 mm triple grouser  
 Unit: kg

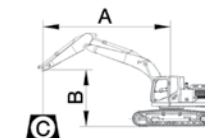

A: Load radius  
 B: Load point height  
 C: Lifting capacity  
 Cf: Rating over front  
 Cs: Rating over side

B (m)	A (Unit: m)												A (m)		
	1.5		3		4.5		6		7.5		MAX REACH				
7.5							*5,260	*5,260			*4,480	*4,480	6.2		
6.0							*5,550	*5,550			*4,270	*4,270	7.3		
4.5							*7,000	*7,000	*6,200	6,010	*5,880	4,360	*4,700	4,030	7.9
3.0							*9,150	8,600	*7,200	5,790	*6,320	4,260	*4,580	3,690	8.3
1.5							*11,140	8,130	*8,220	5,560	6,480	4,150	*4,650	3,579	8.4
GROUND LEVEL			*7,320	*7,320	*12,250	7,890	8,760	5,410	6,390	4,070	*5,130	3,640	8.2		
-1.5	*7,950	*7,950	*12,140	*12,140	*12,450	7,820	8,680	5,340	6,360	4,050	6,250	3,980	7.6		
-3.0	*12,810	*12,810	*16,800	14,720	*11,800	7,880	8,730	5,380			7,330	4,620	6.8		
-4.5			*13,780	*13,780	*9,830	8,090					*7,910	6,350	5.4		





**LIFTING CAPACITY (IMPERIAL)**

922E with 32" shoes, 9'7" arm

**Conditions**

Boom length: 18'9"  
 Arm length: 9'7"  
 Bucket: None  
 Counterweight: 8,818 lb  
 Shoes: 32" triple grouser  
 Unit: lbs

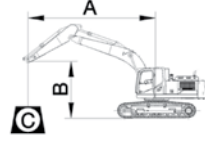

A: Load radius  
 B: Load point height  
 C: Lifting capacity  
 Cf: Rating over front  
 Cs: Rating over side

B (ft)	A (Unit: ft)											A (ft)	
	5		10		15		20		25		MAX REACH		
25							*11,596	*11,596			*9,876	*9,876	20.3
20							*12,235	*12,235			*9,413	*9,413	24.0
15					*15,432	*15,432	*13,668	13,051	*12,963	9,457	*10,361	8,752	25.9
10					*20,172	18,651	*15,873	12,544	*13,933	9,237	*10,097	8,002	27.2
5					*24,559	17,636	*18,121	12,059	14,065	8,994	*10,251	7,738	27.6
GROUND LEVEL			*16,137	*16,137	*27,006	17,085	19,003	11,706	13,867	8,818	*11,309	7,870	26.9
- 5	*17,526	*17,526	*26,764	*26,764	*27,447	16,953	18,849	11,574	13,800	8,774	13,558	8,642	24.9
- 10	*28,241	*28,241	*37,037	31,900	*26,014	17,085	18,937	11,640			15,895	10,008	22.3
- 15			*30,379	*30,379	*21,671	17,548					*17,438	13,778	17.7

922E with 35" shoes, 9'7" arm

**Conditions**

Boom length: 18'9"  
 Arm length: 9'7"  
 Bucket: None  
 Counterweight: 8,818 lb  
 Shoes: 35" triple grouser  
 Unit: lbs

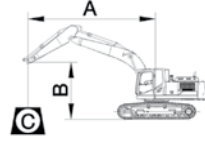

A: Load radius  
 B: Load point height  
 C: Lifting capacity  
 Cf: Rating over front  
 Cs: Rating over side

B (ft)	A (Unit: ft)											A (ft)	
	5		10		15		20		25		MAX REACH		
25							*11,596	*11,596			*9,876	*9,876	20.3
20							*12,235	*12,235			*9,413	*9,413	24.0
15					*15,432	*15,432	*13,668	13,249	*12,963	9,612	*10,361	8,884	25.9
10					*20,172	18,959	*15,873	12,764	*13,933	9,391	*10,097	8,135	27.2
5					*24,559	17,923	*18,121	12,257	14,285	9,149	*10,251	7,890	27.6
GROUND LEVEL			*16,137	*16,137	*27,006	17,394	19,312	11,927	14,087	8,972	*11,309	8,024	26.9
- 5	*17,526	*17,526	*26,764	*26,764	*27,447	17,240	19,136	11,772	14,021	8,928	13,778	8,774	24.9
- 10	*28,241	*28,241	*37,037	32,452	*26,014	17,372	19,246	11,860			16,159	10,185	22.3
- 15			*30,379	*30,379	*21,671	17,835					*17,438	13,999	17.7

**LIFTING CAPACITY (METRIC)**

925E with 600 mm shoes, 2,400 mm arm

**Conditions**

Boom length: 6,000 mm  
 Arm length: 2,400 mm  
 Bucket: None  
 Counterweight: 5,000 kg  
 Shoes: 600 mm triple grouser  
 Unit: kg

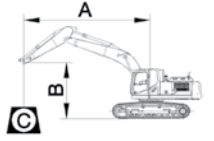

A: Load radius  
 B: Load point height  
 C: Lifting capacity  
 Cf: Rating over front  
 Cs: Rating over side

B (m)	A (Unit: m)										A (m)		
	3.0		4.5		6.0		7.5		MAX REACH				
7.5							*7,530	7,250			*7,530	7,250	6.0
6.0							*7,480	7,240			*6,970	5,440	7.2
4.5					*10,020	*10,020	*8,310	7,020	7,290	5,060	6,710	4,660	7.9
3.0					*12,720	10,050	*9,500	6,730	7,160	4,940	6,270	4,340	8.2
1.5					*14,730	9,540	9,710	6,470	7,020	4,810	6,080	4,190	8.3
GROUND LEVEL					15,090	9,360	9,530	6,310	6,930	4,720	6,230	4,280	8.1
-1.5	*12,680	*12,680	*15,030	9,350	9,480	6,260	6,920	4,720	6,800	4,640	6,800	4,640	7.6
-3.0	*18,640	*18,640	*13,790	9,480	9,570	6,340			8,190	5,520	8,190	5,520	6.7
-4.5			*10,900	9,780					*9,170	7,980	*9,170	7,980	5.2

925E with 700 mm shoes, 2,400 mm arm

**Conditions**

Boom length: 6,000 mm  
 Arm length: 2,400 mm  
 Bucket: None  
 Counterweight: 5,000 kg  
 Shoes: 700 mm triple grouser  
 Unit: kg

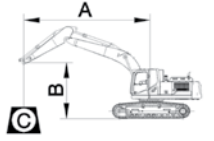

A: Load radius  
 B: Load point height  
 C: Lifting capacity  
 Cf: Rating over front  
 Cs: Rating over side

B (m)	A (Unit: m)										A (m)		
	3.0		4.5		6.0		7.5		MAX REACH				
7.5							*7,530	7,360			*7,530	7,360	6.0
6.0							*7,480	7,350			*6,970	5,520	7.2
4.5					*10,020	*10,020	*8,310	7,130	7,400	5,140	*6,750	4,740	7.9
3.0					*12,720	10,210	*9,500	6,840	7,270	5,020	6,370	4,420	8.2
1.5					*14,730	9,700	9,870	6,580	7,130	4,890	6,180	4,270	8.3
GROUND LEVEL					*15,330	9,520	9,680	6,420	7,040	4,800	6,340	4,360	8.1
-1.5	*12,680	*12,680	*15,030	9,520	9,630	6,370	7,030	4,800	6,910	4,720	6,910	4,720	7.6
-3.0	*18,640	*18,640	*13,790	9,640	9,720	6,450			8,320	5,620	8,320	5,620	6.7
-4.5			*10,900	9,940					*9,170	8,110	*9,170	8,110	5.2





**LIFTING CAPACITY (IMPERIAL)**

925E with 24" shoes, 7'10" arm

**Conditions**

Boom length: 19'8"  
 Arm length: 7'10"  
 Bucket: None  
 Counterweight: 11,023 lbs  
 Shoes: 24" triple grouser  
 Unit: lbs

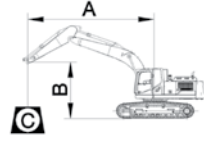

B (ft)	A (Unit: ft)										
	10		15		20		25		MAX REACH		A (ft)
25					*16,600	15,980			*16,600	15,980	19.7
20					*16,490	15,960			*15,360	11,990	23.6
15			*22,090	*22,090	*18,320	15,470	16,070	11,150	14,790	10,270	25.9
10			*28,040	22,150	*20,940	14,830	15,780	10,890	13,820	9,560	26.9
5			*32,470	21,030	21,400	14,260	15,470	10,600	13,400	9,230	27.2
GROUND LEVEL			33,260	20,630	21,010	13,910	15,270	10,400	13,730	9,430	26.6
-5	*27,950	*27,950	*33,130	20,610	20,890	13,800	15,250	10,400	14,990	10,220	24.9
-10	*41,090	*41,090	*30,400	20,890	21,090	13,970			18,050	12,160	22.0
-15			*24,030	21,560					*20,210	17,590	17.1

925E with 28" shoes, 7'10" arm

**Conditions**

Boom length: 19'8"  
 Arm length: 7'10"  
 Bucket: None  
 Counterweight: 11,023 lbs  
 Shoes: 28" triple grouser  
 Unit: lbs

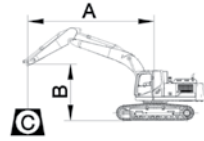

B (ft)	A (Unit: ft)										
	10		15		20		25		MAX REACH		A (ft)
	Cf	Cs	Cf	Cs	Cf	Cs	Cf	Cs	Cf	Cs	
25					*16,600	16,220			*16,600	16,220	19.7
20					*16,490	16,200			*15,360	12,160	23.6
15			*22,090	*22,090	*18,320	15,710	16,310	11,330	*14,880	10,440	25.9
10			*28,040	22,500	*20,940	15,070	16,020	11,060	14,040	9,740	26.9
5			*32,470	21,380	21,750	14,500	15,710	10,780	13,620	9,410	27.2
GROUND LEVEL			*33,790	20,980	21,340	14,150	15,520	10,580	13,970	9,610	26.6
-5	*27,950	*27,950	*33,130	20,980	21,230	14,040	15,490	10,580	15,230	10,400	24.9
-10	*41,090	*41,090	*30,400	21,250	21,420	14,210			18,340	12,380	22.0
-15			*24,030	21,910					*20,210	17,870	17.1

**LIFTING CAPACITY (METRIC)**

925E with 800 mm shoes, 2,400 mm arm

**Conditions**

Boom length: 6,000 mm  
 Arm length: 2,400 mm  
 Bucket: None  
 Counterweight: 5,000 kg  
 Shoes: 800 mm triple grouser  
 Unit: kg

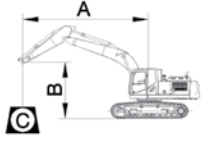

B (m)	A (Unit: m)										
	3.0		4.5		6.0		7.5		MAX REACH		A (m)
7.5					*7,530	7,470			*7,530	7,470	6.0
6.0					*7,480	7,460			*6,970	5,610	7.2
4.5			*10,020	*10,020	*8,310	7,240	7,520	5,220	*6,750	4,820	7.9
3.0			*12,720	10,370	*9,500	6,950	7,380	5,100	6,470	4,490	8.2
1.5			*14,730	9,860	10,020	6,690	7,250	4,970	6,270	4,340	8.3
GROUND LEVEL			*15,360	9,680	9,840	6,530	7,150	4,890	6,440	4,430	8.1
-1.5	*12,680	*12,680	*15,030	9,680	9,790	6,480	7,140	4,880	7,020	4,800	7.6
-3.0	*18,640	*18,640	*13,790	9,800	9,870	6,560			8,450	5,710	6.7
-4.5			*10,900	10,100					*9,170	8,250	5.2

925E with 900 mm shoes, 2,400 mm arm

**Conditions**

Boom length: 6,000 mm  
 Arm length: 2,400 mm  
 Bucket: None  
 Counterweight: 5,000 kg  
 Shoes: 900 mm triple grouser  
 Unit: kg

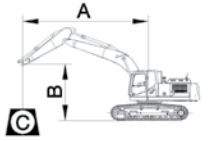

B (m)	A (Unit: m)										
	3.0		4.5		6.0		7.5		MAX REACH		A (m)
	Cf	Cs	Cf	Cs	Cf	Cs	Cf	Cs	Cf	Cs	
7.5					*7,530	*7,530			*7,530	*7,530	6.0
6.0					*7,480	*7,480			*6,970	5,700	7.2
4.5			*10,020	*10,020	*8,310	7,350	*7,600	5,300	*6,750	4,900	7.9
3.0			*12,720	10,530	*9,500	7,060	7,500	5,180	6,570	4,560	8.2
1.5			*14,730	10,020	10,170	6,800	7,360	5,060	6,370	4,410	8.3
GROUND LEVEL			*15,360	9,840	9,990	6,640	7,260	4,970	6,540	4,510	8.1
-1.5	*12,680	*12,680	*15,030	9,840	9,940	6,590	7,260	4,960	7,130	4,880	7.6
-3.0	*18,640	*18,640	*13,790	9,960	10,030	6,670			8,580	5,810	6.7
-4.5			*10,900	10,260					*9,170	8,380	5.2





**LIFTING CAPACITY (IMPERIAL)**

925E with 32" shoes, 7'10" arm

**Conditions**

Boom length: 19'8"  
 Arm length: 7'10"  
 Bucket: None  
 Counterweight: 11,023 lbs  
 Shoes: 32" triple grouser  
 Unit: lbs

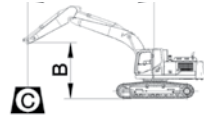

A: Load radius  
 B: Load point height  
 C: Lifting capacity  
 Cf: Rating over front  
 Cs: Rating over side

B (ft)	A (Unit: ft)										
	10		15		20		25		MAX REACH		A (ft)
	Cf	Cs	Cf	Cs	Cf	Cs	Cf	Cs	Cf	Cs	
25					*16,600	16,460			*16,600	16,460	19.7
20					*16,490	16,440			*15,360	12,360	23.6
15			*22,090	*22,090	*18,320	15,960	16,570	11,500	*14,880	10,620	25.9
10			*28,040	22,860	*20,940	15,320	16,270	11,240	14,260	9,890	26.9
5			*32,470	21,730	22,090	14,740	15,980	10,950	13,820	9,560	27.2
GROUND LEVEL			*33,860	21,340	21,690	14,390	15,760	10,780	14,190	9,760	26.6
-5	*27,950	*27,950	*33,130	21,340	21,580	14,280	15,740	10,750	15,470	10,580	24.9
-10	*41,090	*41,090	*30,400	21,600	21,750	14,460			18,620	12,580	22.0
-15			*24,030	22,260					*20,210	18,180	17.1

925E with 35" shoes, 7'10" arm

**Conditions**

Boom length: 19'8"  
 Arm length: 7'10"  
 Bucket: None  
 Counterweight: 11,023 lbs  
 Shoes: 35" triple grouser  
 Unit: lbs

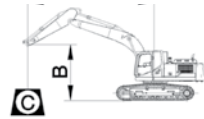

A: Load radius  
 B: Load point height  
 C: Lifting capacity  
 Cf: Rating over front  
 Cs: Rating over side

B (ft)	A (Unit: ft)										
	10		15		20		25		MAX REACH		A (ft)
	Cf	Cs	Cf	Cs	Cf	Cs	Cf	Cs	Cf	Cs	
25					*16,600	*16,600			*16,600	*16,600	19.7
20					*16,490	*16,490			*15,360	12,560	23.6
15			*22,090	*22,090	*18,320	16,200	*16,750	11,680	*14,880	10,800	25.9
10			*28,040	23,210	*20,940	15,560	16,530	11,410	14,480	10,050	26.9
5			*32,470	22,090	22,420	14,990	16,220	11,150	14,040	9,720	27.2
GROUND LEVEL			*33,860	21,690	22,020	14,630	16,000	10,950	14,410	9,940	26.6
-5	*27,950	*27,950	*33,130	21,690	21,910	14,520	16,000	10,930	15,710	10,750	24.9
-10	*41,090	*41,090	*30,400	21,950	22,110	14,700			18,910	12,800	22.0
-15			*24,030	22,610					*20,210	18,470	17.1

**LIFTING CAPACITY (METRIC)**

925E with 600 mm shoes, 2,980 mm arm

**Conditions**

Boom length: 6,000 mm  
 Arm length: 2,980 mm  
 Bucket: None  
 Counterweight: 5,000 kg  
 Shoes: 600 mm triple grouser  
 Unit: kg

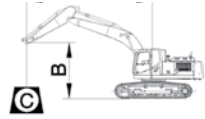

A: Load radius  
 B: Load point height  
 C: Lifting capacity  
 Cf: Rating over front  
 Cs: Rating over side

B (m)	A (Unit: m)											
	3.0		4.5		6.0		7.5		MAX REACH		A (m)	
	Cf	Cs	Cf	Cs	Cf	Cs	Cf	Cs	Cf	Cs		
7.5										*5,340	*5,340	6.7
6.0					*6,710	*6,710	*6,440	5,170	*5,360	4,960	7.7	
4.5					*7,610	7,110	*7,020	5,100	*4,950	4,270	8.4	
3.0			*11,580	10,260	*8,870	6,790	7,190	4,950	*5,440	3,990	8.7	
1.5			*13,940	9,650	9,750	6,500	7,020	4,800	*5,470	3,850	8.8	
GROUND LEVEL			15,090	9,350	9,520	6,290	6,890	4,690	5,700	3,920	8.6	
-1.5	*13,360	*13,360	15,000	9,270	9,420	6,200	6,840	4,640	6,170	4,210	8.1	
-3.0	*20,270	18,440	*14,380	9,340	9,450	6,230			7,160	4,850	7.3	
-4.5	*16,920	*16,920	*12,280	9,560	*8,850	6,420			*8,850	6,420	6.0	

925E with 700 mm shoes, 2,980 mm arm

**Conditions**

Boom length: 6,000 mm  
 Arm length: 2,980 mm  
 Bucket: None  
 Counterweight: 5,000 kg  
 Shoes: 700 mm triple grouser  
 Unit: kg

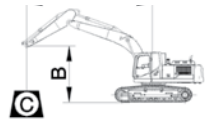

A: Load radius  
 B: Load point height  
 C: Lifting capacity  
 Cf: Rating over front  
 Cs: Rating over side

B (m)	A (Unit: m)											
	3.0		4.5		6.0		7.5		MAX REACH		A (m)	
	Cf	Cs	Cf	Cs	Cf	Cs	Cf	Cs	Cf	Cs		
7.5										*5,340	*5,340	6.7
6.0					*6,710	*6,710	*6,440	5,260	*5,360	5,030	7.7	
4.5					*7,610	7,210	*7,020	5,180	*4,950	4,350	8.4	
3.0			*11,580	10,420	*8,870	6,900	7,300	5,030	*5,440	4,050	8.7	
1.5			*13,940	9,810	9,900	6,600	7,130	4,880	*5,470	3,920	8.8	
GROUND LEVEL			*15,110	9,510	9,670	6,400	7,010	4,770	5,790	3,990	8.6	
-1.5	*13,360	*13,360	*15,200	9,430	9,570	6,310	6,950	4,720	6,270	4,290	8.1	
-3.0	*20,270	18,750	*14,380	9,500	9,600	6,340			7,270	4,940	7.3	
-4.5	*16,920	*16,920	*12,280	9,720	*8,850	6,530			*8,850	6,530	6.0	





**LIFTING CAPACITY (IMPERIAL)**

925E with 24" shoes, 9'9" arm

**Conditions**

Boom length: 19'8"  
 Arm length: 9'9"  
 Bucket: None  
 Counterweight: 11,023 lbs  
 Shoes: 24" triple grouser  
 Unit: lbs

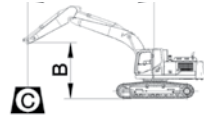

B (ft)	A (Unit: ft)										A (ft)
	10		15		20		25		MAX REACH		
	Cf	Cs	Cf	Cs	Cf	Cs	Cf	Cs	Cf	Cs	
25									*11,770	*11,770	22.0
20					*14,790	*14,790	*14,190	11,390	*11,810	10,930	25.3
15					*16,770	15,670	*15,470	11,240	*10,910	9,410	27.6
10			*25,520	22,610	*19,550	14,960	15,850	10,910	*11,990	8,790	28.5
5			*30,730	21,270	21,490	14,330	15,470	10,580	*12,050	8,480	28.9
GROUND LEVEL			33,260	20,610	20,980	13,860	15,180	10,330	12,560	8,640	28.2
-5	*29,450	*29,450	33,060	20,430	20,760	13,660	15,070	10,220	13,600	9,280	26.6
-10	*44,680	40,650	*31,700	20,590	20,830	13,730			15,780	10,690	24.0
-15	*37,300	*37,300	*27,070	21,070	*19,510	14,150			*19,510	14,150	19.7

925E with 28" shoes, 9'9" arm

**Conditions**

Boom length: 19'8"  
 Arm length: 9'9"  
 Bucket: None  
 Counterweight: 11,023 lbs  
 Shoes: 28" triple grouser  
 Unit: lbs

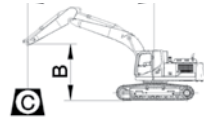

B (ft)	A (Unit: ft)										A (ft)
	10		15		20		25		MAX REACH		
	Cf	Cs	Cf	Cs	Cf	Cs	Cf	Cs	Cf	Cs	
25									*11,770	*11,770	22.0
20					*14,790	*14,790			*11,810	11,080	25.3
15					*16,770	15,890	*15,470	11,410	*10,910	9,590	27.6
10			*25,520	22,970	*19,550	15,210	*16,090	11,080	*11,990	8,920	28.5
5			*30,730	21,620	21,820	14,550	15,710	10,750	*12,050	8,640	28.9
GROUND LEVEL			33,310	20,960	21,310	14,100	15,450	10,510	12,760	8,790	28.2
-5	*29,450	*29,450	*33,510	20,780	21,090	13,910	15,320	10,400	13,820	9,450	26.6
-10	*44,680	41,330	*31,700	20,940	21,160	13,970			16,020	10,890	24.0
-15	*37,300	*37,300	*27,070	21,420					*19,510	14,390	19.7

**LIFTING CAPACITY (METRIC)**

925E with 800 mm shoes, 2,980 mm arm

**Conditions**

Boom length: 6,000 mm  
 Arm length: 2,980 mm  
 Bucket: None  
 Counterweight: 5,000 kg  
 Shoes: 800 mm triple grouser  
 Unit: kg

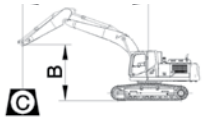

B (m)	A (Unit: m)										A (m)		
	3.0		4.5		6.0		7.5		MAX REACH				
	Cf	Cs	Cf	Cs	Cf	Cs	Cf	Cs	Cf	Cs			
7.5											*5,340	*5,340	6.7
6.0					*6,710	*6,710	*6,440	5,340	*5,360	5,110	7.7		
4.5					*7,610	7,320	*7,020	5,260	*4,950	4,420	8.4		
3.0			*11,580	10,580	*8,870	7,010	7,410	5,120	*5,440	4,120	8.7		
1.5			*13,940	9,970	10,060	6,710	7,240	4,970	*5,470	3,990	8.8		
GROUND LEVEL			*15,110	9,670	9,830	6,510	7,120	4,850	5,890	4,060	8.6		
-1.5	*13,360	*13,360	*15,200	9,590	9,720	6,420	7,060	4,800	6,370	4,360	8.1		
-3.0	*20,270	19,060	*14,380	9,660	9,750	6,440			7,390	5,020	7.3		
-4.5	*16,920	*16,920	*12,280	9,880	*8,850	6,640			*8,850	6,640	6.0		

925E with 900 mm shoes, 2,980 mm arm

**Conditions**

Boom length: 6,000 mm  
 Arm length: 2,980 mm  
 Bucket: None  
 Counterweight: 5,000 kg  
 Shoes: 900 mm triple grouser  
 Unit: kg

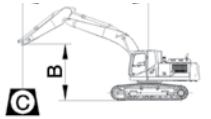

B (m)	A (Unit: m)										A (m)		
	3.0		4.5		6.0		7.5		MAX REACH				
	Cf	Cs	Cf	Cs	Cf	Cs	Cf	Cs	Cf	Cs			
7.5											*5,340	*5,340	6.7
6.0					*6,710	*6,710	*6,440	5,420	*5,360	5,190	7.7		
4.5					*7,610	7,430	*7,020	5,340	*4,950	4,490	8.4		
3.0			*11,580	10,740	*8,870	7,120	7,520	5,200	*5,440	4,190	8.7		
1.5			*13,940	10,130	*10,120	6,820	7,360	5,050	*5,470	4,050	8.8		
GROUND LEVEL			*15,110	9,830	9,980	6,620	7,230	4,930	5,980	4,130	8.6		
-1.5	*13,360	*13,360	*15,200	9,750	9,880	6,530	7,180	4,880	6,470	4,440	8.1		
-3.0	*20,270	19,370	*14,380	9,820	9,910	6,550			7,510	5,110	7.3		
-4.5	*16,920	*16,920	*12,280	10,040	*8,850	6,750			*8,850	6,750	6.0		





**LIFTING CAPACITY (IMPERIAL)**

925E with 32" shoes, 9'9" arm

Conditions

A: Load radius  
B: Load point height  
C: Lifting capacity  
Cf: Rating over front  
Cs: Rating over side

Boom length: 19'8"  
Arm length: 9'9"  
Bucket: None  
Counterweight: 11,023 lbs  
Shoes: 32" triple grouser  
Unit: lbs

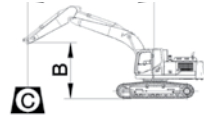

B (ft)	A (Unit: ft)										A (ft)
	10		15		20		25		MAX REACH		
	Cf	Cs	Cf	Cs	Cf	Cs	Cf	Cs	Cf	Cs	
25									*11,770	*11,770	22.0
20					*14,790	*14,790	*14,190	11,770	*11,810	11,260	25.3
15					*16,770	16,130	*15,470	11,590	*10,910	9,740	27.6
10			*25,520	23,320	*19,550	15,450	16,330	11,280	*11,990	9,080	28.5
5			*30,730	21,980	22,170	14,790	15,960	10,950	*12,050	8,790	28.9
GROUND LEVEL			*33,310	21,310	21,670	14,350	15,690	10,690	12,980	8,950	28.2
-5	*29,450	*29,450	*33,510	21,140	21,420	14,150	15,560	10,580	14,040	9,610	26.6
-10	*44,680	42,020	*31,700	21,290	21,490	14,190			16,290	11,060	24.0
-15	*37,300	*37,300	*27,070	21,780	*19,510	14,630			*19,510	14,630	19.7

925E with 35" shoes, 9'9" arm

Conditions

A: Load radius  
B: Load point height  
C: Lifting capacity  
Cf: Rating over front  
Cs: Rating over side

Boom length: 19'8"  
Arm length: 9'9"  
Bucket: None  
Counterweight: 11,023 lbs  
Shoes: 35" triple grouser  
Unit: lbs

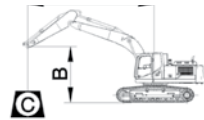

B (ft)	A (Unit: ft)										A (ft)
	10		15		20		25		MAX REACH		
	Cf	Cs	Cf	Cs	Cf	Cs	Cf	Cs	Cf	Cs	
25									*11,770	*11,770	22.0
20					*14,790	*14,790	*14,190	11,940	*11,810	11,440	25.3
15					*16,770	16,380	*15,470	11,770	*10,910	9,890	27.6
10			*25,520	23,670	*19,550	15,690	16,570	11,460	*11,990	9,230	28.5
5			*30,730	22,330	*22,310	15,030	16,220	11,130	*12,050	8,920	28.9
GROUND LEVEL			*33,310	21,670	22,000	14,590	15,930	10,860	13,180	9,100	28.2
-5	*29,450	*29,450	*33,510	21,490	21,780	14,390	15,820	10,750	14,260	9,780	26.6
-10	*44,680	42,700	*31,700	21,640	21,840	14,440			16,550	11,260	24.0
-15	*37,300	*37,300	*27,070	22,130	*19,510	14,880			*19,510	14,880	19.7

**LIFTING CAPACITY (METRIC)**

925E with 600 mm shoes, 3,500 mm arm

Conditions

A: Load radius  
B: Load point height  
C: Lifting capacity  
Cf: Rating over front  
Cs: Rating over side

Boom length: 6,000mm  
Arm length: 3,500mm  
Bucket: None  
Counterweight: 5,000 kg  
Shoes: 600mm triple grouser  
Unit: kg

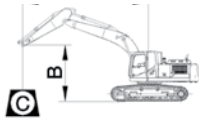

B (m)	A (Unit: m)										A (m)										
	3.0		4.5		6.0		7.5		9.0			MAX REACH									
	Cf	Cs	Cf	Cs	Cf	Cs	Cf	Cs	Cf	Cs	Cf	Cs									
7.5													*4,950	*4,950	7.2						
6.0									*6,080	5,230			*4,670	4,510	8.2						
4.5									*6,920	*6,920	*6,480	5,120		*4,740	3,980	8.8					
3.0									*10,460	10,410	*8,220	6,830	*7,150	4,950	5,450	3,780	*5,050	3,710	9.1		
1.5									*13,030	9,690	*9,560	6,490	7,000	4,770	5,370	3,690	*5,150	3,580	9.2		
GROUND LEVEL									*8,450	*8,450	*14,600	9,270	9,470	6,230	6,840	4,630	5,300	3,630	5,300	3,630	9.0
-1.5									*12,700	*12,700	14,830	9,110	9,320	6,100	6,750	4,550			5,690	3,880	8.5
-3.0									*18,420	18,010	*14,620	9,130	9,300	6,090	6,760	4,560			6,420	4,350	7.8
-4.5									*18,430	18,400	*13,060	9,310	9,440	6,210					8,240	5,500	6.6

925E with 700 mm shoes, 3500 mm arm

Conditions

A: Load radius  
B: Load point height  
C: Lifting capacity  
Cf: Rating over front  
Cs: Rating over side

Boom length: 6,000 mm  
Arm length: 3,500 mm  
Bucket: None  
Counterweight: 5,000 kg  
Shoes: 700 mm triple grouser  
Unit: kg

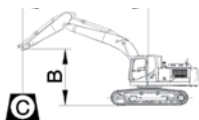

B (m)	A (Unit: m)										A (m)														
	3.0		4.5		6.0		7.5		9.0			MAX REACH													
	Cf	Cs	Cf	Cs	Cf	Cs	Cf	Cs	Cf	Cs	Cf	Cs													
7.5													*4,950	*4,950	7.2										
6.0													*6,080	5,310		*4,670	4,590	8.2							
4.5													*6,920	*6,920	*6,480	5,200	5,540	3,840	*4,740	4,050	8.8				
3.0													*10,460	*10,460	*8,220	6,940	*7,150	5,030	5,450	3,760	*5,050	3,780	9.1		
1.5													*13,030	9,850	*9,560	6,590	7,110	4,850	5,380	3,690	*5,150	3,640	9.2		
GROUND LEVEL													*8,450	*8,450	*14,600	9,430	9,620	6,340	6,950	4,710			5,380	3,690	9.0
-1.5													*12,700	*12,700	15,070	9,270	9,470	6,210	6,860	4,630			5,790	3,950	8.5
-3.0													*18,420	18,320	*14,620	9,300	9,460	6,190	6,880	4,640			6,530	4,430	7.8
-4.5													*18,430	*18,430	*13,060	9,470	9,600	6,320					8,370	5,600	6.6







**LIFTING CAPACITY (IMPERIAL)**

925E with 32" shoes, 11'6" arm

A: Load radius  
 B: Load point height  
 C: Lifting capacity  
 Cf: Rating over front  
 Cs: Rating over side

Conditions:

Boom length: 19'8" one-piece boom  
 Arm length: 11'6"  
 Bucket: None  
 Counterweight: 11,023 lbs  
 Shoes: 32" triple grouser  
 Unit: lbs

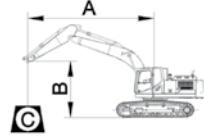

B (ft)	A (Unit: ft)													
	10	15	20	25	30	MAX REACH		A (ft)						
25												*10,910	*10,910	23.6
20												*10,290	10,270	26.9
15												*10,440	9,080	28.9
10												*11,130	8,460	29.9
5												*11,350	8,170	30.2
GROUND LEVEL	*18,620	*18,620	*32,180	21,140	21,530	14,210	15,560	10,560				12,050	8,280	29.5
-5	*27,990	*27,990	*33,220	20,780	21,200	13,930	15,360	10,380				12,960	8,860	27.9
-10	*40,600	*40,600	*32,230	20,850	21,180	13,880	15,410	10,400				14,610	9,920	25.6
-15	*40,630	*40,630	*28,790	21,230	*21,400	14,170						18,760	12,540	21.7

925E with 35" shoes, 11'6" arm

A: Load radius  
 B: Load point height  
 C: Lifting capacity  
 Cf: Rating over front  
 Cs: Rating over side

Conditions:

Boom length: 19'8"  
 Arm length: 11'6"  
 Bucket: None  
 Counterweight: 11,023 lbs  
 Shoes: 35" triple grouser  
 Unit: lbs

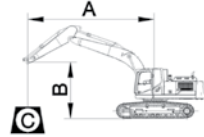

B (ft)	A (Unit: ft)														
	10		15		20		25		30		MAX REACH		A (ft)		
	Cf	Cs	Cf	Cs	Cf	Cs	Cf	Cs	Cf	Cs	Cf	Cs			
25													*10,910	*10,910	23.6
20													*10,290	*10,290	26.9
15													*10,440	9,230	28.9
10													*11,130	8,620	29.9
5													*11,350	8,310	30.2
GROUND LEVEL	*18,620	*18,620	*32,180	21,490	21,890	14,460	15,800	10,730				12,250	8,420	29.5	
-5	*27,990	*27,990	*33,220	21,160	21,530	14,150	15,630	10,560				13,180	9,010	27.9	
-10	*40,600	*40,600	*32,230	21,200	21,510	14,130	15,650	10,580				14,850	10,090	25.6	
-15	*40,630	*40,630	*28,790	21,600	*21,400	14,410						*18,800	12,760	21.7	

# STANDARD EQUIPMENT

**ENGINE SYSTEM**

- Cummins diesel engine, turbocharged, inline 6-cylinder, 4-stroke, water cooled
- Auto-idle speed control
- Air filter with pre-cleaner
- Engine oil filter
- Pre-filter with water separator
- Radiator, oil cooler and intercooler
- IPC (Intelligent Power Control) System
- Engine overheating prevention system

**DRIVETRAIN**

- Hydraulic motor, one-piece two-gear piston and reducer
- 2-speed travel system with automatic shift

**SWING SYSTEM**

- High-torque piston swing motor with integral spring set and automatic hydraulic release swing brake

**HYDRAULIC SYSTEM**

- Main pump: two variable displacement piston pumps, ready for PTO
- Pilot pump: gear
- Cylinders: boom, arm, bucket
- Power boost function
- Boom and arm regeneration circuits
- Pilot oil filter
- Load holding valve
- Pilot control shut-off lever
- Hose burst safety valves, prevention of boom or arm supply dropped when the lines split (2 mounted on boom cylinders, 1 on arm cylinder)
- 6-working mode selection system: Power, Economy, Fine, Lifting, Breaker, Attachment

**DIGGING EQUIPMENT**

- 922E
- 5,710 mm (18'9") boom
  - 2,915 mm (9'7") arm
  - 1 m<sup>3</sup> (1.31 yd<sup>3</sup>) (SAE, heaped) bucket
  - Counterweight, 4,000 kg (8,818 lbs)
- 925E
- 6,000 mm (19'8") boom
  - 2,980 mm (9'9") arm
  - 1.2 m<sup>3</sup> (1.57 yd<sup>3</sup>) (SAE, heaped) bucket
  - Counterweight, 5,000 kg (11,023 lbs)

**OPERATOR STATION**

- Pressurized and sealed cab with all-around visibility, large roof window with slide sliding sun visor, front window wiper and removable lower window
- Mechanical suspension seat
- Skylight rooftop
- Air conditioner, heater, defroster
- Swing parking brake
- AM/FM radio with MP3 audio jack
- Glass-breaking hammer
- Ashtray, cigarette lighter
- Cup holder
- Floor mat
- Storage box
- Front glass lower guard
- Fire extinguisher
- Rear view mirrors
- One key for all locks

**INSTRUMENTATION**

- Color LCD monitor with alarms, filter/fluid change, fuel rate, water temperature, work mode, fault code, working hour, etc.
- Fuel gauge
- Hydraulic oil level gauge

**ELECTRICAL**

- Alternator 70 A
- Dual batteries 2 x 12 V
- Working lights, 1 frame mounted, 2 boom mounted
- Rotating beacon
- Starting, 24 V

**UNDERCARRIAGE**

- 600 mm (24") track-shoes with triple grousers
- 2 piece track-guards (each side)
- Towing eye on base frame

**GUARDS**

- Belly guards
- Cover plate under travel frame
- Track shields

**OTHER STANDARD EQUIPMENT**

- Maintenance tool kit
- Maintenance parts package

# OPTIONAL EQUIPMENT

**ENGINE SYSTEM**

- Electrical fuel refilling pump

**HYDRAULIC SYSTEM**

- Control pattern change valve
- Hydraulic lines: Breaker & shear Slope & rotator Grapple Oil drain line Quick coupler
- Hydraulic quick coupler
- Overloading valve
- Cushion valve

**OPERATOR STATION**

- Power outlet 24 V to 12 V converter
- 4 LED cab top lights
- Roll-Over Protective System (ROPS)
- Working lights on cab (2 on top-front cab)
- Rear view camera 5.7" monitor

**DIGGING EQUIPMENT**

- Air suspension seat
- Control joysticks with 2 switch & 1 proportional
- Safety net for front window
- Rain visor
- Travel alarm
- Operation protection guard (included cab front and top guard, bar)
- Operation protection screen (on cab front, net)
- Operation protection screen (front-lower)

**UPPER STRUCTURE**

- Upper frame protection (wire)
- Belly guard and 8 mm thickness platform bottom plate
- Bucket cylinder guard
- Counterweight, 922E 5,000 kg (11,023 lbs) 925E 6,800 kg (14,991 lbs)

**UNDERCARRIAGE**

- 3 piece track-guards (each side)
- 700 mm, 800 mm, 900 mm (28",32"35") track-shoes with triple grousers

**DIGGING EQUIPMENT**

- Hydraulic hammers (LiuGong & Soosan)
- Hydraulic quick coupler
- Quartered grapple

922E

- 8,500 mm (27'11") boom
- Arm: 2,700 mm (8'10"), 6,400 mm (21')
- Bucket: 0.5/0.9/0.95/1.0/1.1/1.2 m<sup>3</sup> (0.65/1.18/1.24/1.31/1.44/1.57 yd<sup>3</sup>)

925E

- Boom: 8,500 mm (27'11")
- Arm: 2.4 m (7'10"), 6.4 m (21')
- Bucket: 0.58/1.1/1.3/1.4 m<sup>3</sup> (0.76/1.44/1.7/1.83 yd<sup>3</sup>)



**Guangxi LiuGong Machinery Co., Ltd.**

No. 1 Liutai Road, Liuzhou, Guangxi 545007, PR China  
T: +86 772 388 6124 E: overseas@liugong.com  
www.liugong.com

Like and follow us:



**LG-PB-922E/925E-T4F-WW-44-042020-ENG**

The LiuGong series of logos herein, including but not limited to word marks, device marks, letter of alphabet marks and combination marks, as the registered trademarks of Guangxi LiuGong Group Co., Ltd. are used by Guangxi LiuGong Machinery Co., Ltd. with legal permission, and shall not be used without permission. Specifications and designs are subject to change without notice. Illustrations and pictures may include optional equipment and may not include all standard equipment. Equipment and options varies by regional availability.